



2a

WAIST

TAILLE

CINTURA

KNIT DIRECTION
SENS DES MAILLES
SENTIDO DE LAS MALLAS

1a



HEM-FOLDLINE

PLIURE DE L'OURLET

DOBLADILLO-LINEA DE DOBLEZ

1 1/4" (3cm)

HEM ALLOWANCE

VALEUR D'OURLET

MARGEN DE DOBLADILLO

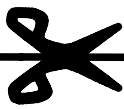

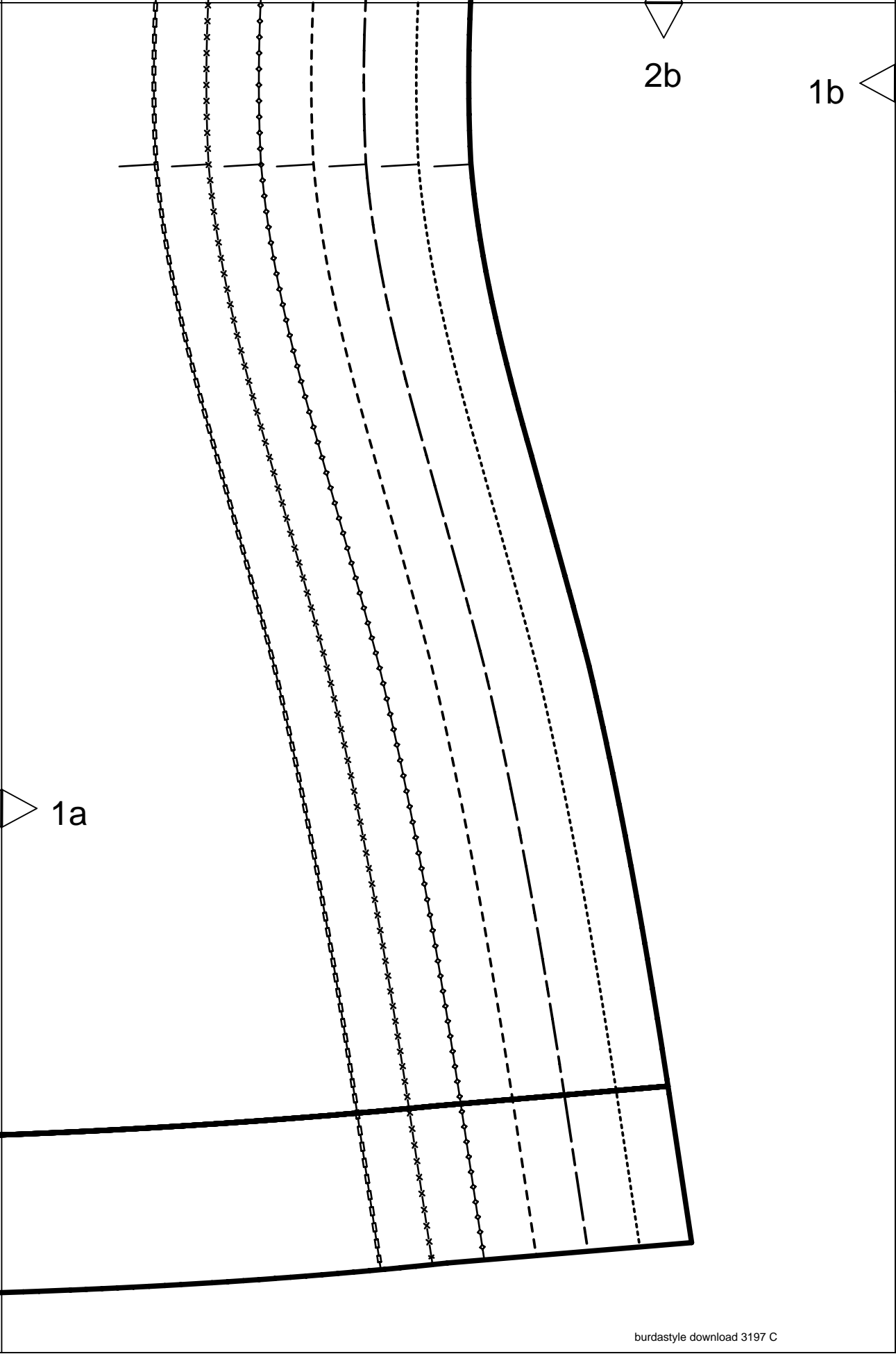

1b

2c

1c

| Size Taille Talla | | 32 | 34 | 36 | 38 | 40 | 42 | 44 | 46 | 48 | 50 | 52 | 54 | 56 | 58 | 60 |
|-------------------------|--------|--------|--------|--------|--------|--------|--------|--------|--------|--------|--------|--------|--------|--------|--------|--------|
| 1 | inches | 66 1/4 | 66 1/4 | 66 1/4 | 66 1/4 | 66 1/4 | 66 1/4 | 66 1/4 | 66 1/4 | 66 1/4 | 66 1/4 | 66 1/4 | 66 1/4 | 66 1/4 | 66 1/4 | 66 1/4 |
| | cm | 168 | 168 | 168 | 168 | 168 | 168 | 168 | 168 | 168 | 168 | 168 | 168 | 168 | 168 | 168 |
| 2 | inches | 30 | 31 1/2 | 33 | 34 3/4 | 36 1/4 | 37 3/4 | 39 1/2 | 41 | 43 1/2 | 45 1/2 | 48 | 50 1/2 | 52 3/4 | 55 1/4 | 57 1/2 |
| | cm | 76 | 80 | 84 | 88 | 92 | 96 | 100 | 104 | 110 | 116 | 122 | 128 | 134 | 140 | 146 |
| 3 | inches | 23 | 24 1/2 | 26 | 27 3/4 | 29 1/4 | 30 3/4 | 32 1/2 | 34 | 36 1/4 | 38 3/4 | 41 | 43 1/2 | 45 1/2 | 48 | 50 1/2 |
| | cm | 58 | 62 | 66 | 70 | 74 | 78 | 82 | 86 | 92 | 98 | 104 | 110 | 116 | 122 | 128 |
| 4 | inches | 32 1/2 | 34 | 35 1/2 | 37 | 38 3/4 | 40 1/4 | 41 3/4 | 43 1/2 | 45 1/2 | 48 | 50 1/2 | 52 3/4 | 55 1/4 | 57 1/2 | 60 |
| | cm | 82 | 86 | 90 | 94 | 98 | 102 | 106 | 110 | 115 | 122 | 128 | 134 | 140 | 146 | 152 |
| 5 | inches | 15 3/4 | 16 | 16 1/4 | 16 1/2 | 16 1/2 | 16 3/4 | 17 | 17 1/4 | 17 1/4 | 17 1/2 | 17 3/4 | 18 | 18 1/4 | 18 1/2 | 18 1/2 |
| | cm | 40 | 40,5 | 41 | 41,5 | 42 | 42,5 | 43 | 43,5 | 44 | 44,5 | 45 | 45,5 | 46 | 46,5 | 47 |
| 6 | inches | 23 1/4 | 23 1/4 | 23 1/4 | 23 3/4 | 23 3/4 | 24 | 24 | 24 | 24 | 24 1/2 | 24 1/2 | 24 1/2 | 24 3/4 | 24 3/4 | 24 3/4 |
| | cm | 59 | 59 | 59 | 60 | 60 | 61 | 61 | 61 | 61 | 62 | 62 | 62 | 63 | 63 | 63 |
| 7 | inches | 13 | 13 1/2 | 14 1/4 | 14 1/2 | 14 3/4 | 15 | 15 1/2 | 15 3/4 | 16 1/4 | 16 1/2 | 17 | 17 1/4 | 17 3/4 | 18 1/4 | 18 1/2 |
| | cm | 33 | 34 | 35 | 36 | 37 | 38 | 39 | 40 | 41 | 42 | 43 | 44 | 45 | 46 | 47 |
| 8 | inches | 39 3/4 | 40 1/4 | 40 1/4 | 40 3/4 | 41 | 41 | 41 1/2 | 41 1/2 | 41 1/2 | 41 3/4 | 41 3/4 | 41 3/4 | 42 1/4 | 42 1/2 | 42 1/2 |
| | cm | 101 | 102 | 102 | 103 | 104 | 104 | 105 | 105 | 105 | 106 | 106 | 106 | 107 | 108 | 108 |
| 9 | inches | 16 1/2 | 17 | 17 1/4 | 17 3/4 | 18 1/4 | 18 1/2 | 19 | 19 1/4 | 19 3/4 | 20 1/4 | 20 1/2 | 21 | 21 1/4 | 21 3/4 | 22 1/4 |
| | cm | 42 | 43 | 44 | 45 | 46 | 47 | 48 | 49 | 50 | 51 | 52 | 53 | 54 | 55 | 56 |
| 10 | inches | 9 1/2 | 9 7/8 | 10 1/4 | 10 3/4 | 11 1/8 | 11 1/2 | 11 7/8 | 12 1/4 | 12 3/4 | 13 | 13 1/2 | 14 1/4 | 14 1/2 | 14 3/4 | 15 |
| | cm | 24 | 25 | 26 | 27 | 28 | 29 | 30 | 31 | 32 | 33 | 34 | 35 | 36 | 37 | 38 |
| 11 | inches | 9 7/8 | 10 1/4 | 10 3/4 | 11 1/8 | 11 1/2 | 11 7/8 | 12 1/4 | 12 3/4 | 13 1/2 | 14 1/2 | 15 | 15 3/4 | 16 1/2 | 17 1/4 | 18 1/4 |
| | cm | 25 | 26 | 27 | 28 | 29 | 30 | 31 | 32 | 34 | 36 | 38 | 40 | 42 | 44 | 46 |

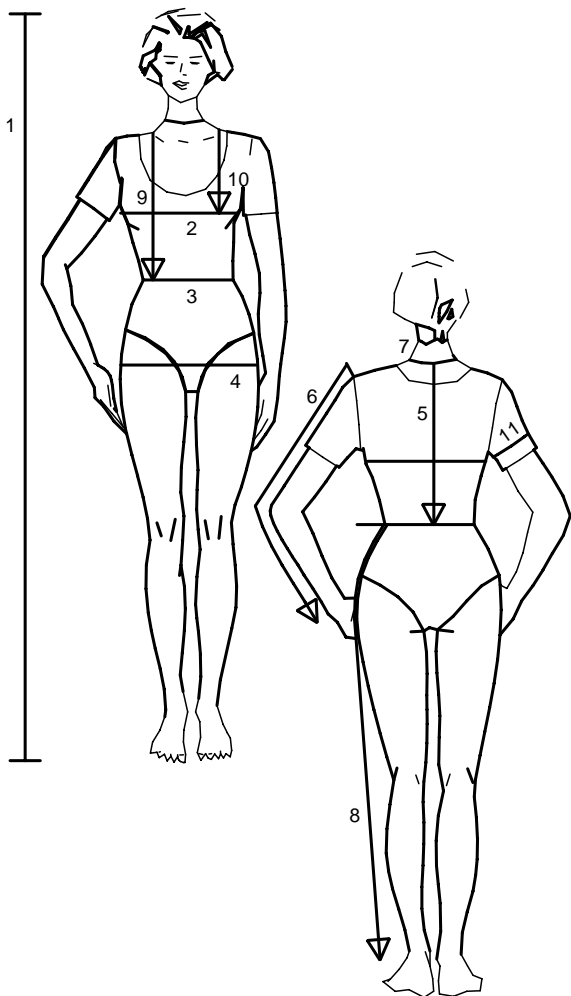

englisch

1. Height
2. Bust
3. Waist
4. Hip
5. Back length
6. Sleeve length
7. Neck width
8. Side leg length
9. Front waist length
10. Bust point
11. Upper arm circumf.

For dresses, blouses, coats and jackets select size according to bust measurement, for trousers and skirts according to hip measurement!
All burda patterns are prepared with ease allowance appropriate for style in question.

français

1. Stature
2. Tour de poitrine
3. Tour de taille
4. Tour de hanches
5. Long. du dos
6. Longueur de manche
7. Tour de cou
8. Long. côté pantalon
9. Long. taille devant
10. Profondeur de poitrine
11. Tour du bras

Robes, corsages, manteaux et vestes seront choisis d'après votre tour de poitrine les pantalons et les jupes d'après votre tour de hanches!
Tous les patrons sont établis avec l'aisance nécessaire selon le genre du modèle.

español

1. Estatura
2. Contorno busto
3. Contorno cintura
4. Contorno cadera
5. Largo espalda
6. Largo manga
7. Contorno cuello
8. Largo lateral del pantalón
9. Largo talle delantero
10. Altura de pecho
11. Cont. de brazo

La talla para los vestidos, blusas, abrigos y chaquetas, se determina de acuerdo con el contorno del busto. Los pantalones y las faldas, de acuerdo con el contorno de las caderas.
En el patrón-Burda se incluyen los márgenes para la holgura necesaria.

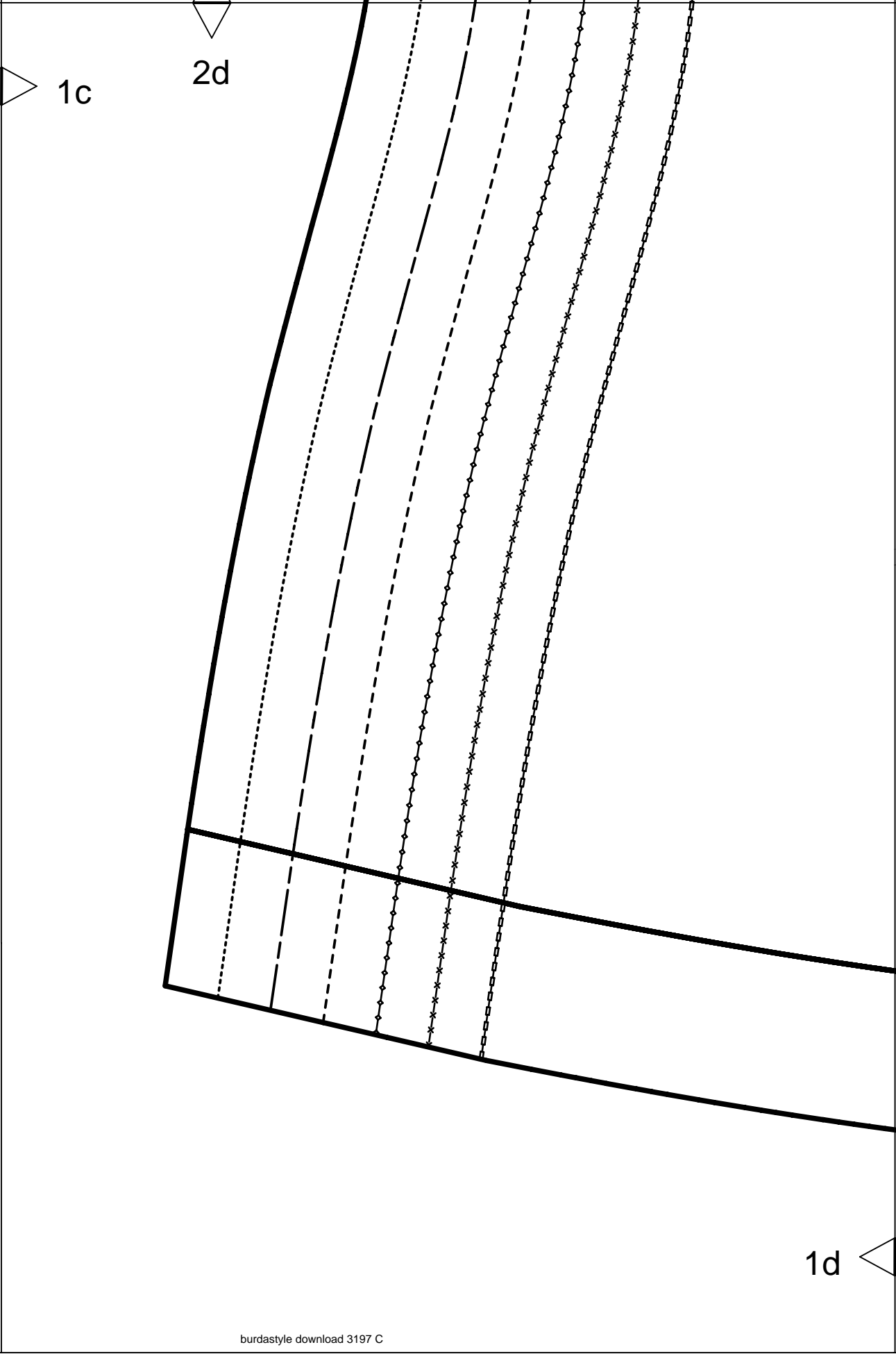

2e

WAIST

TAILLE

CINTURA

KNIT DIRECTION
SENS DES MAILLES
SENTIDO DE LAS MALLAS

HEM-FOLDLINE

PLIURE DE L'OURLET

DOBLADILLO-LINEA DE DOBLEZ

1 1/4" (3cm)
HEM ALLOWANCE
VALEUR D'OURLET
MARGEN DE DOBLADILLO



1d

4a

2

BACK
DOS
ESPALDA



ON THE FOLD
DANS LA PLIURE DU TISSU
CON CANTO DOBLADO

$\frac{5}{8}$ " (1,5cm)

SEAM ALLOWANCE INCLUDED
AVEC VALEUR DE COUTURE
CON MARGEN DE COSTURA

3 1 9 7

3a

KNIT DIRECTION
SENS DES MAILLES
SENTIDO DE LAS MALLAS

CENTER BACK FOLD
PLIURE DU TISSU MILIEU DOS
CENTRO POST. CANTO DE DOBLEZ

Burda
STYLE

www.burdastyle.com

2a

4b

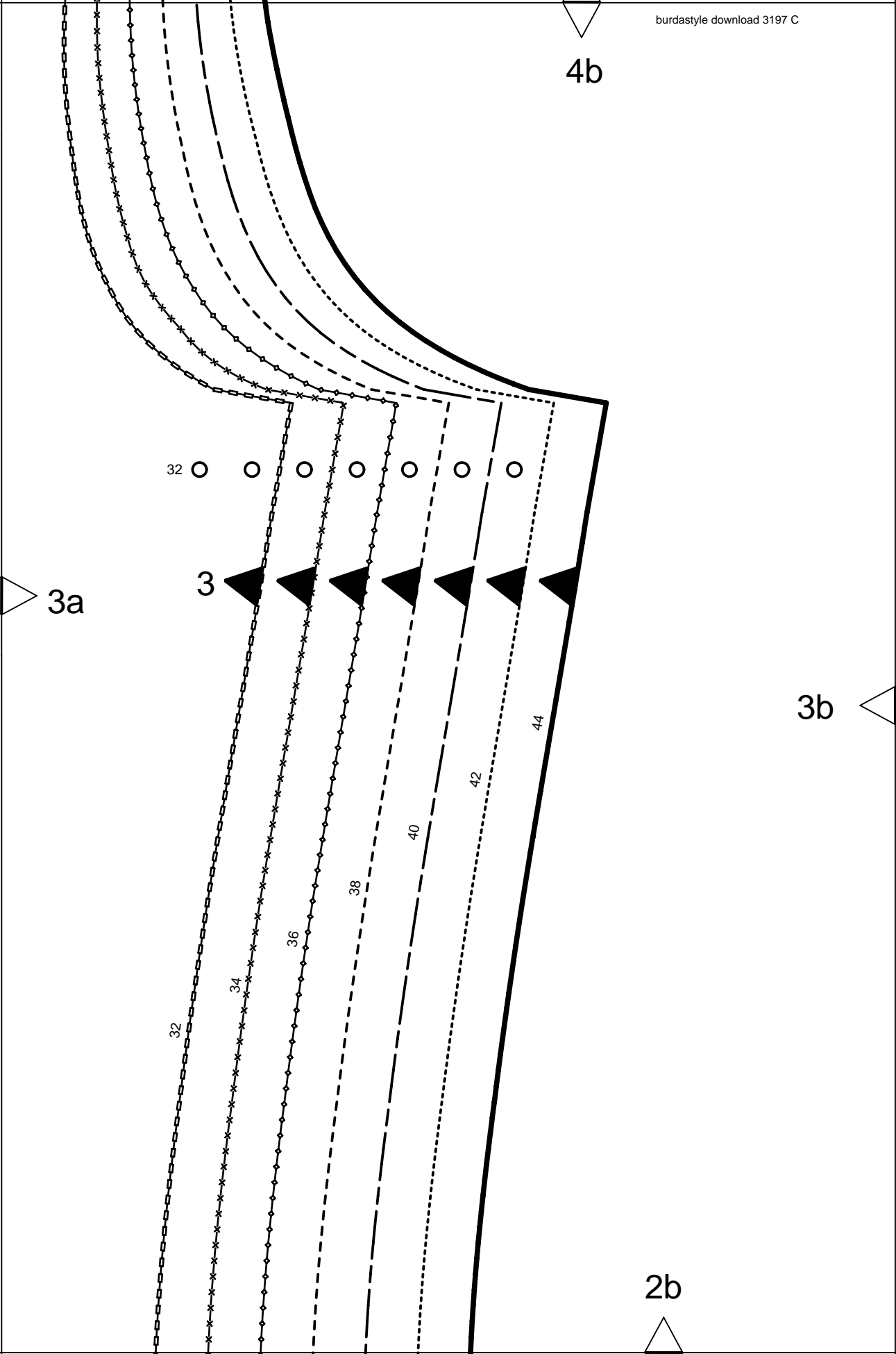

4c

KEY TO SYMBOLS
 LEGENDE
 INTERPRETACION DE LOS SIMBOLOS



SYMBOL FOR STITCHING LINES
 REMARQUE CONCERNANT LES LIGNES DE PIQUES
 INDICACION PARA LINEAS DE PESPUNTE



SEAM ATTACHMENT POINT
 POINT DE RACCORD DE LA COUTURE
 PUNTO DE AJUSTE DE LA COSTURA



SEAM NUMBERS ARE MATCHING SYMBOLS AND DENOTE
 WHERE TWO PIECES SHOULD BE SEWN TOGETHER.
 LES CHIFFRES-REPERES INDIQUENT OU ASSEMBLER LES PIECES.
 LES CHIFFRES IDENTIQUES COINCIDENT.
 LOS NUMEROS DE COSTURA INDICAN DONDE LAS PIEZAS.
 LOS MISMOS NUMEROS CONCIDEN.



GATHER BETWEEN THE STARS.
 FRONCER ENTRE LES ASTERISQUES.
 EMBEBER ENTRE LAS ESTRELLAS.



EASE IN BETWEEN THE DOTS.
 SOUTENIR ENTRE LES POINTS.
 EMBEBER ENTRE LOS PUNTOS.

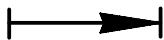

POSITION PLEATS IN DIRECTION OF ARROW.
 POSER LES PLIS DANS LE SENS DES FLECHES.
 PONER LOS PLIEQUES SEGUN LA FLECHA.



SYMBOL INDICATING THE BEGINNING OR END OF VENT.
 REPERE DE DEBUT OU DE FIN DE FENTE.
 MARCA PARA EL PRINCIPIO O FINAL DE LA ABERTURA.



SLASH
 FENTE
 CORTE



BUTTONHOLE
 BOUTONNIERE
 OIAL



BUTTON OR SNAP
 BOUTON OU BOUTON-PRESSION
 BOTON O BROCHE DE PRESION

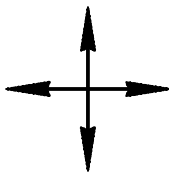

SEE CUTTING DIAGRAMS FOR STRAIGHT GRAIN OF FABRIC
 SENS DU DROIT-FIL VOIR LES PLANS DE COUPE
 DIRECCION DEL HILO, VEANSE PLANOS DE CORTE

3b

3c

2c

4d

3d

3c

2d

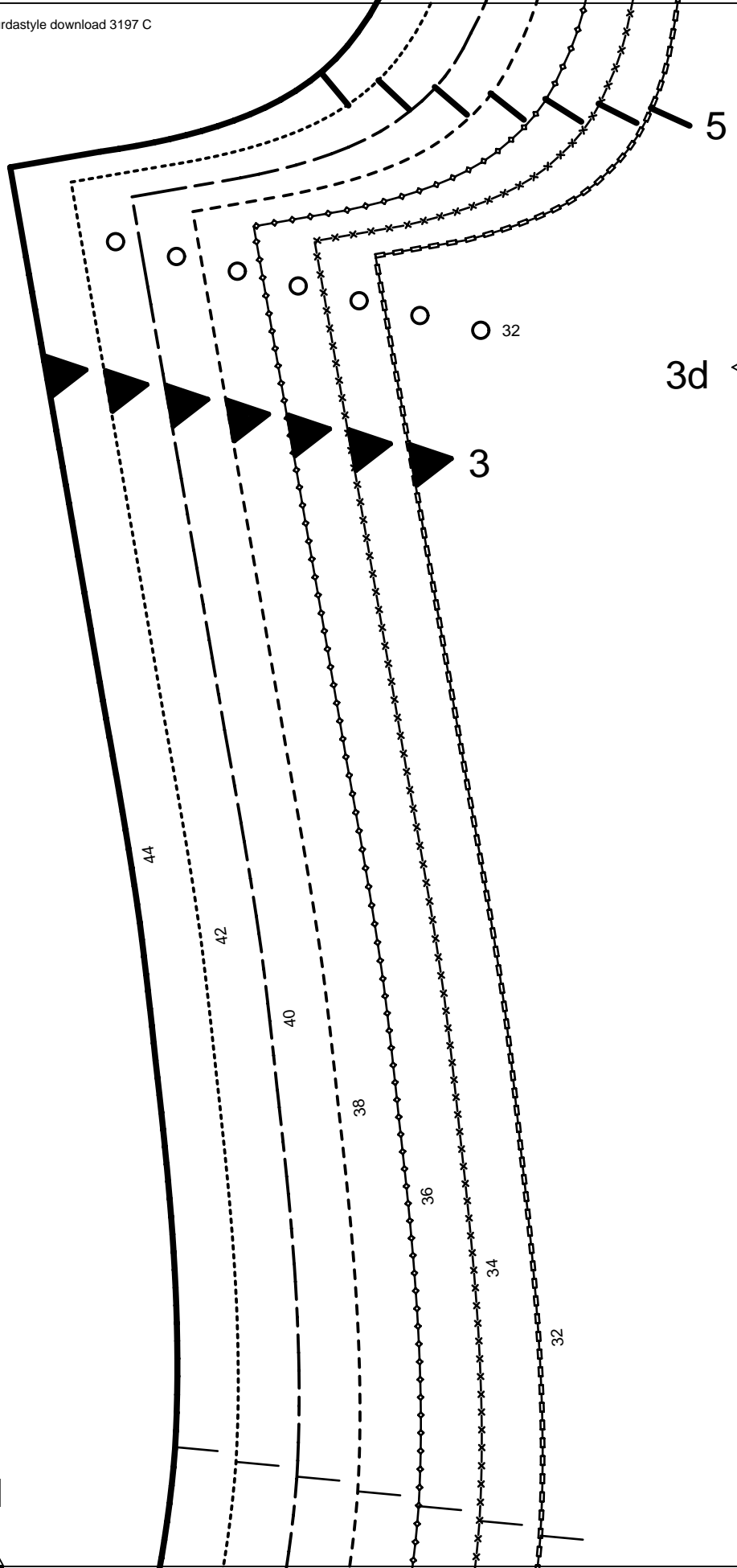

4e

3d

1

FRONT
DEVANT
DELANTERO



ON THE FOLD
DANS LA PLIURE DU TISSU
CON CANTO DOBLADO

5/8" (1,5cm)

SEAM ALLOWANCE INCLUDED
AVEC VALEUR DE COUTURE
CON MARGEN DE COSTURA

3 1 9 7

Burda
STYLE

www.burdastyle.com

KNIT DIRECTION
SENS DES MAILLES
SENTIDO DE LAS MALLAS

CENTER FRONT FOLD
PLIURE DU TISSU MILIEU DEVANT
CENTRO ANTERIOR CANTO DE DOBLEZ

2e

6a

5a

32

1

32

34

36

38

40

42

44

KNIT DIRECTION
SENS DES MAILLES
SENTIDO DE LAS MALLAS

4a

6b

5a

32

4

5b

4b

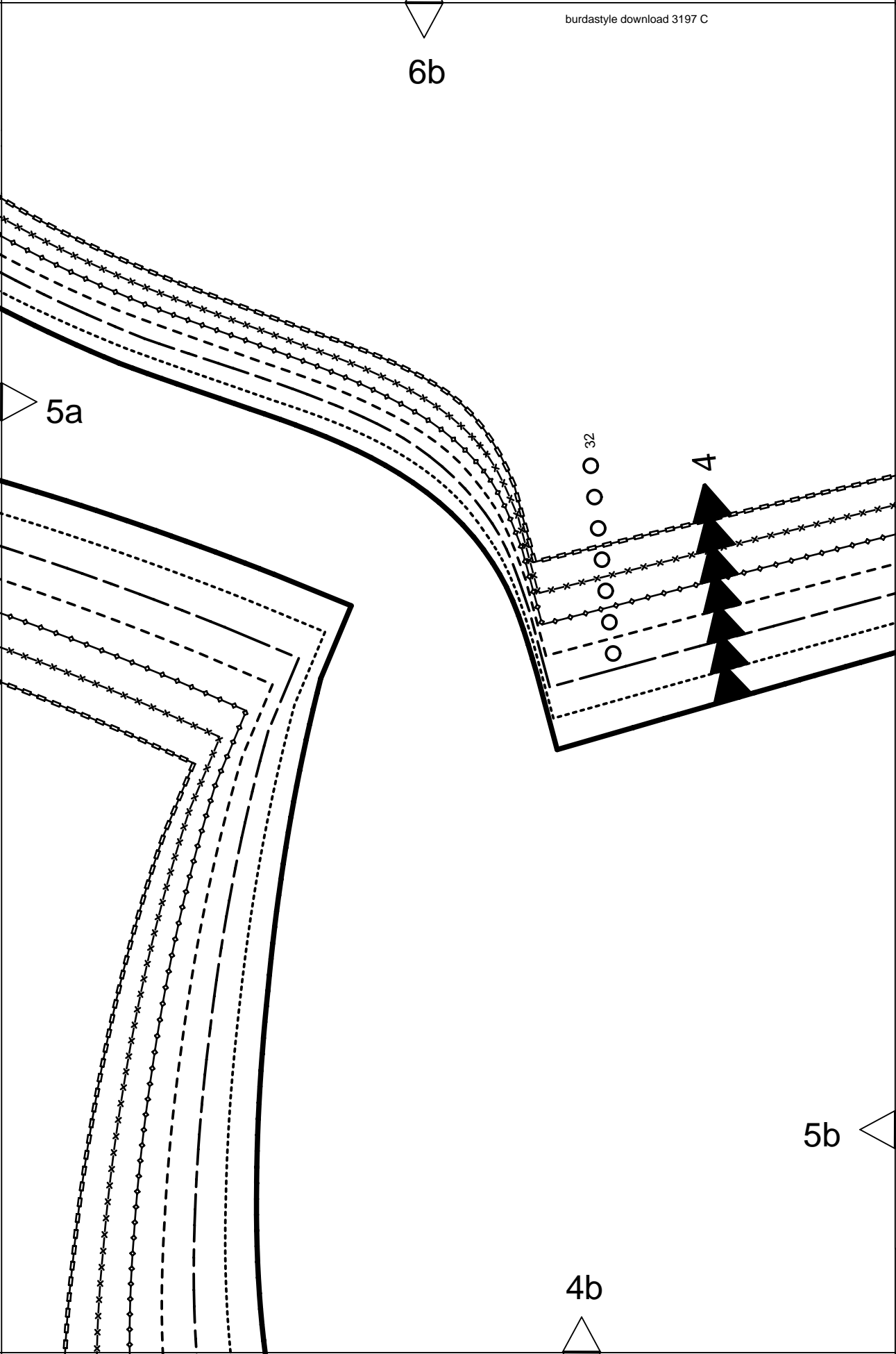

6c

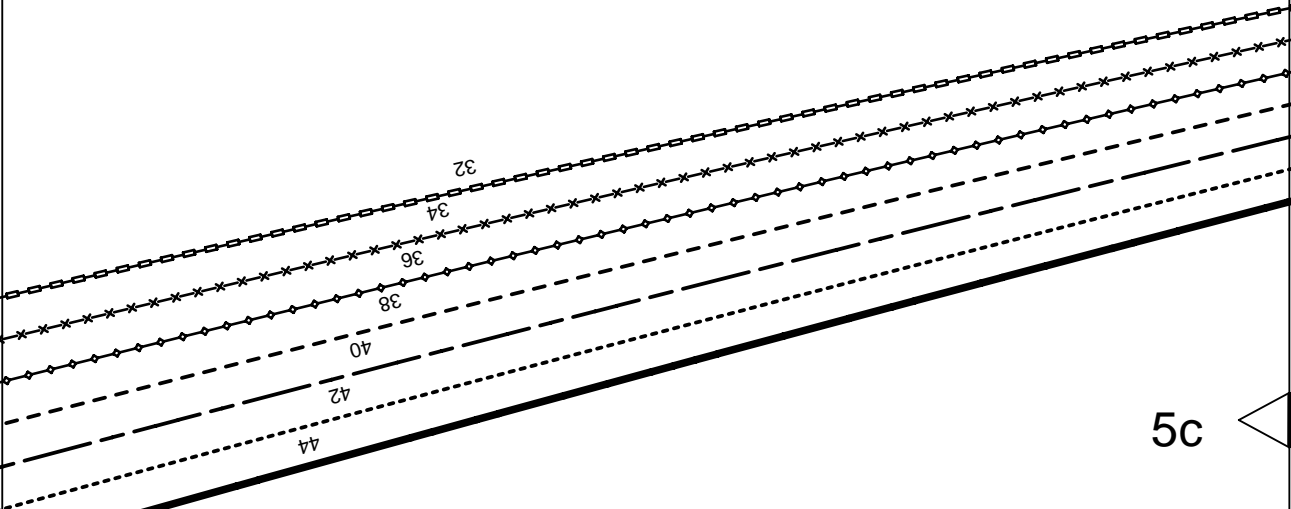

5c

CENTER FRONT FOLD
 PLIURE DU TISSU MILIEU DEVANT
 CENTRO ANTERIOR CANTO DE DOBLEZ
 KNIT DIRECTION
 SENS DES MAILLES
 SENTIDO DE LAS MALLAS



4

FRONT FACING
 PAREMENTURE DEVANT
 VISTA ANTERIOR



ON THE FOLD
 DANS LA PLIURE DU TISSU
 CON CANTO DOBLADO

3197

5b

SEAM ALLOWANCE INCLUDED
 AVEC VALEUR DE COUTURE
 CON MARGEN DE COSTURA

$\frac{5}{8}$ " (1,5cm)

4c

6d

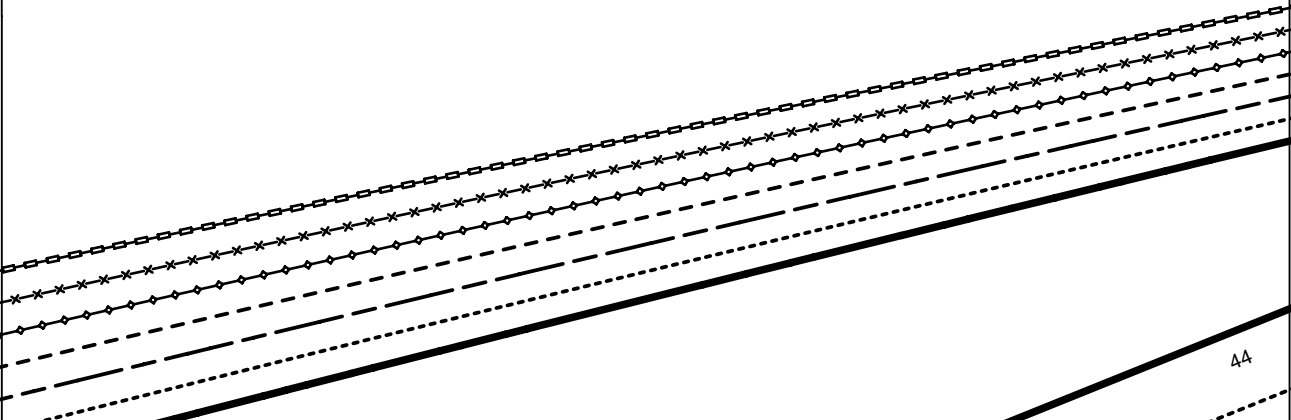

5c

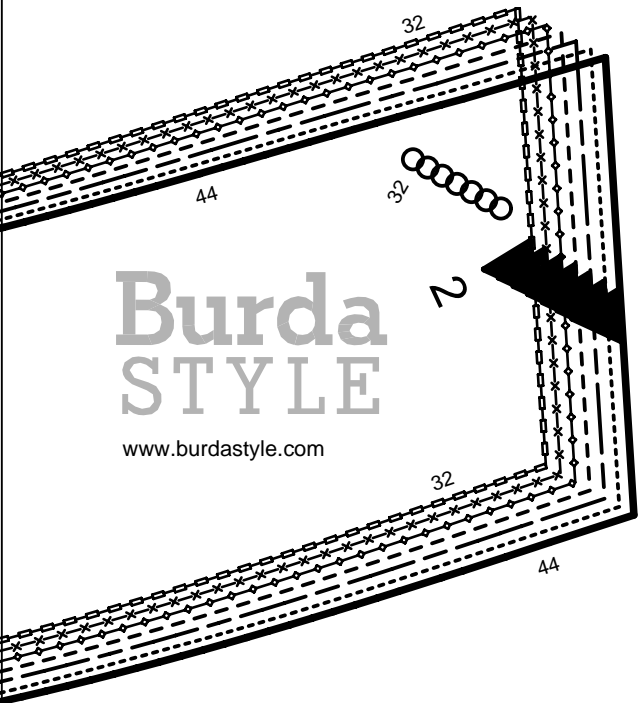

Burda
STYLE

www.burdastyle.com

5d

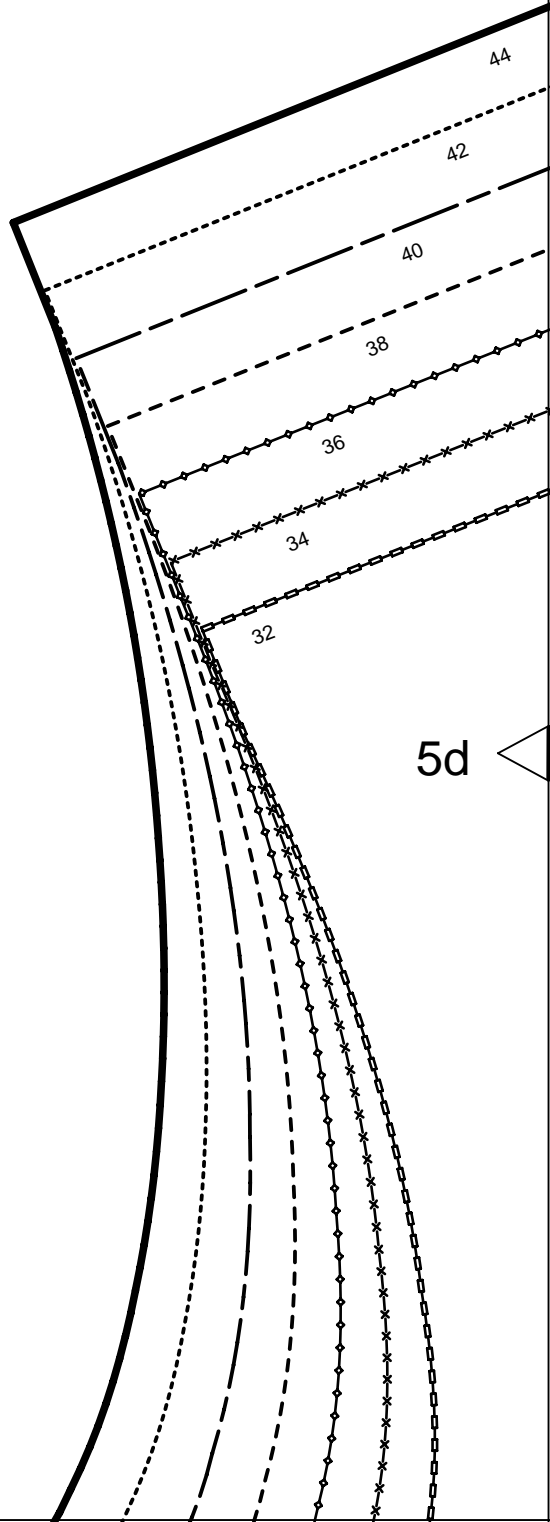

4d



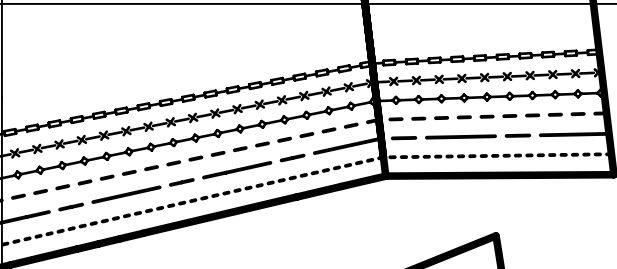

6e

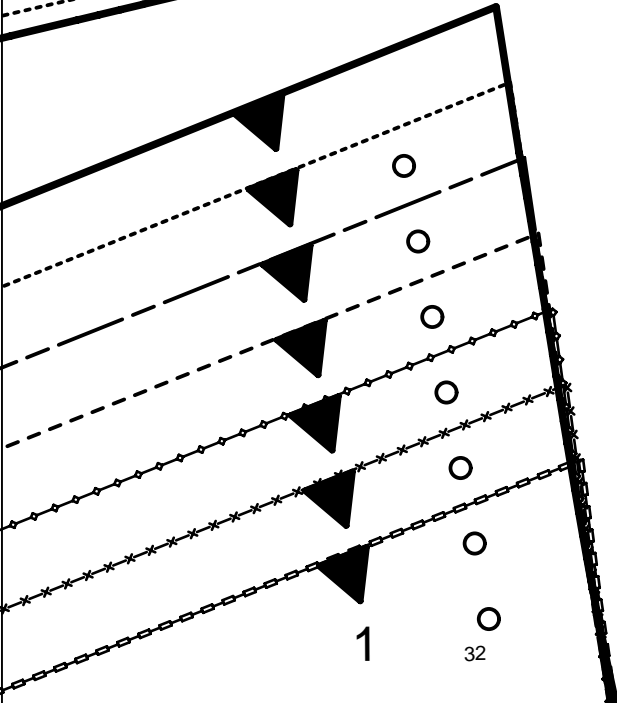

1

32

5d

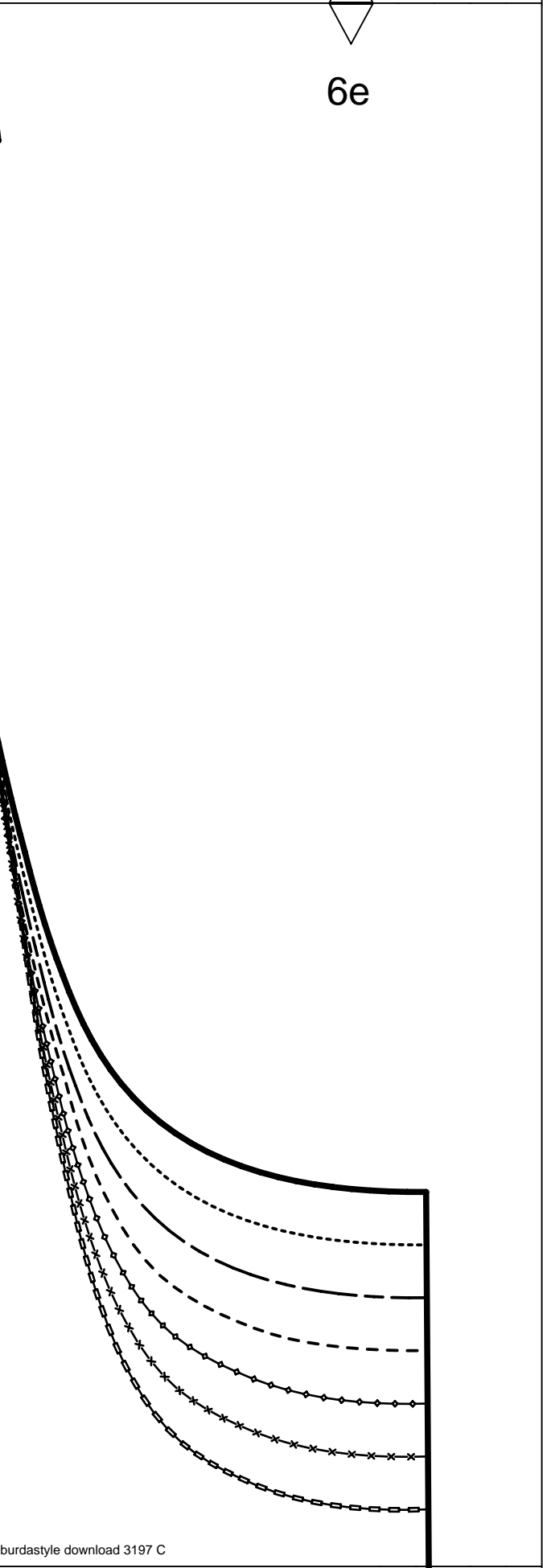

4e

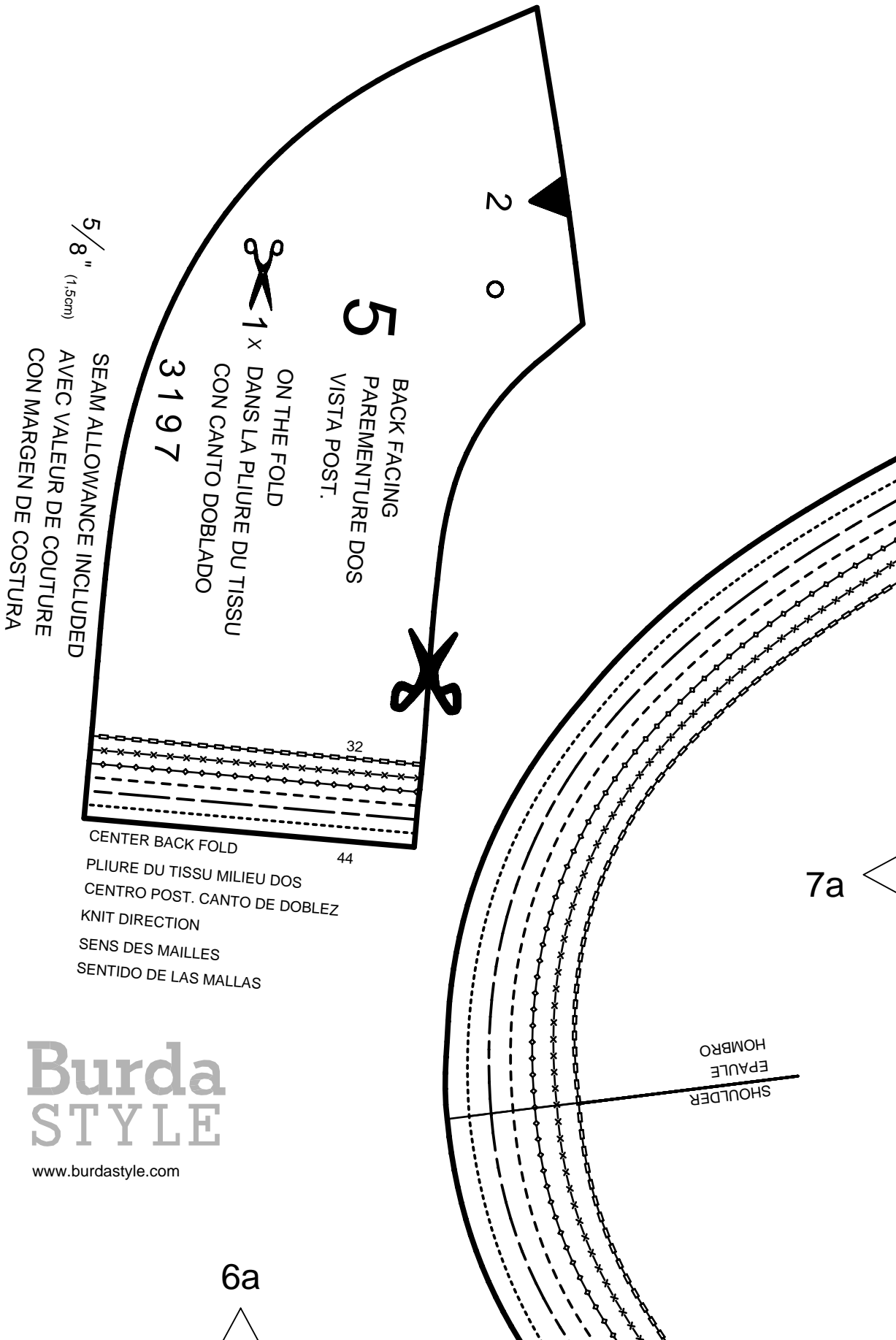

2

0

5

BACK FACING
PAREMENTURE DOS
VISTA POST.

ON THE FOLD

1 x  DANS LA PLIURE DU TISSU
CON CANTO DOBLADO

3 1 9 7

5/8" (1.5cm)
SEAM ALLOWANCE INCLUDED
AVEC VALEUR DE COUTURE
CON MARGEN DE COSTURA

32

44

CENTER BACK FOLD
PLIURE DU TISSU MILIEU DOS
CENTRO POST. CANTO DE DOBLEZ
KNIT DIRECTION
SENS DES MAILLES
SENTIDO DE LAS MALLAS

7a

SHOULDER
EPAULE
HOMBRO

6a

Burda
STYLE

www.burdastyle.com

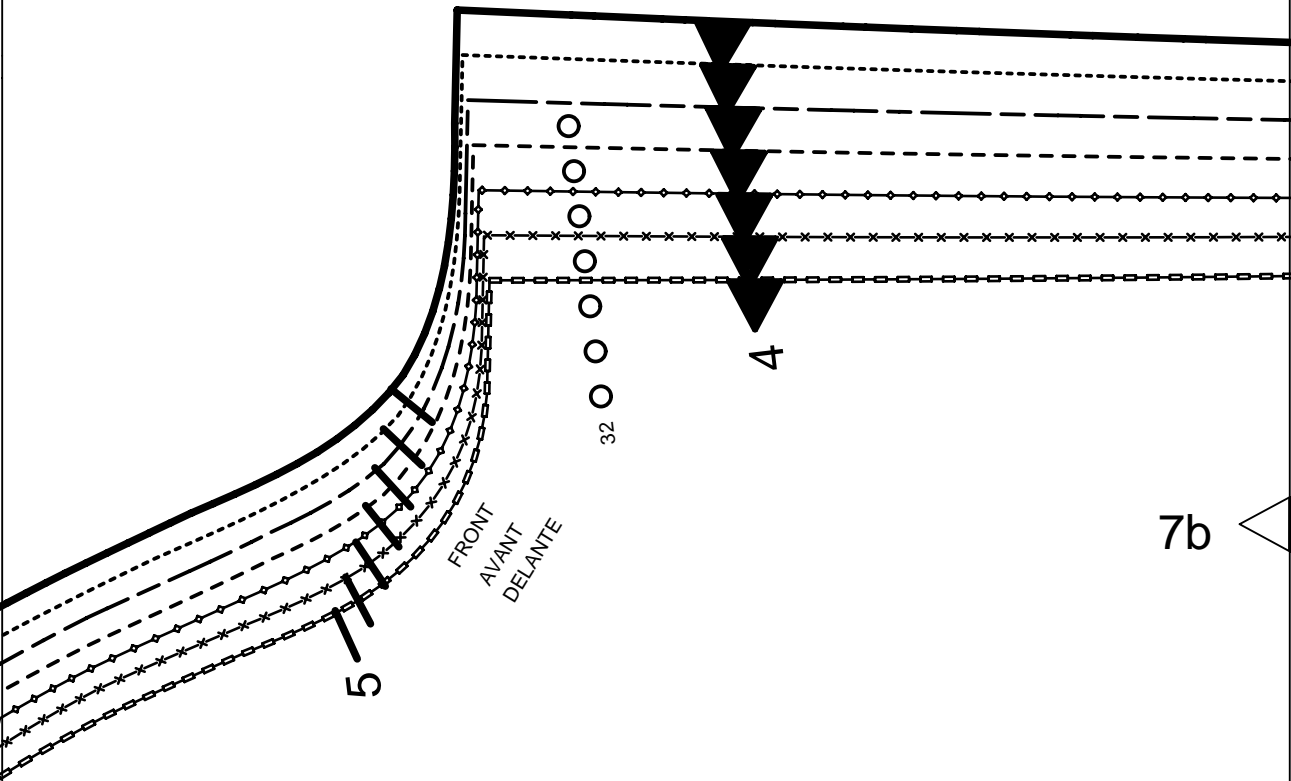

7b

7a

KNIT DIRECTION
SENS DES MAILLES
SENTIDO DE LAS MALLAS

6b

3

SLEEVE
MANCHE
MANGA



SEAM ALLOWANCE INCLUDED
AVEC VALEUR DE COUTURE
CON MARGEN DE COSTURA

5/8" (1,5cm)

3197

Burda
STYLE

www.burdastyle.com

KNIT DIRECTION
SENS DES MAILLES
SENTIDO DE LAS MALLAS

44
42
40
38
36
34
32

7b

7c

6c

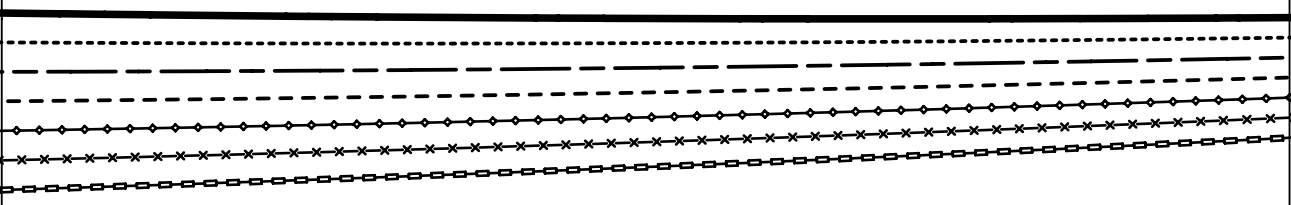

7c

SENTIDO DE LAS MALLAS
SENS DES MAILLES
KNIT DIRECTION

7d

6d



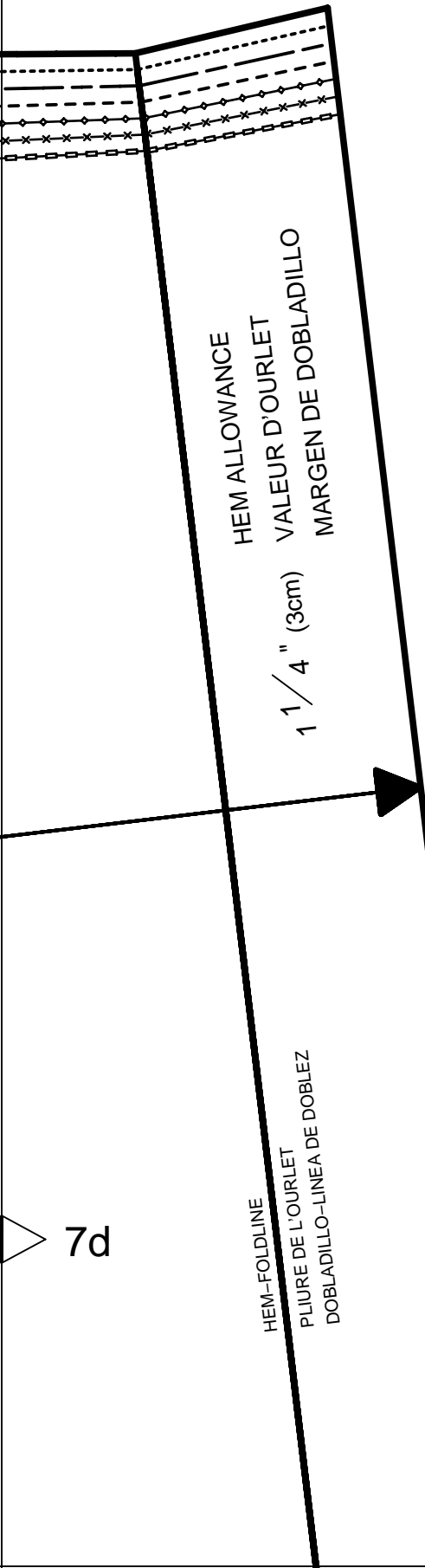

test square

side length

4 inches (10 cm)

Burda
STYLE

www.burdastyle.com

PATTERN LAYOUTS
PLANS DE COUPE
PLANOS DE CORTE

45" 114 CM

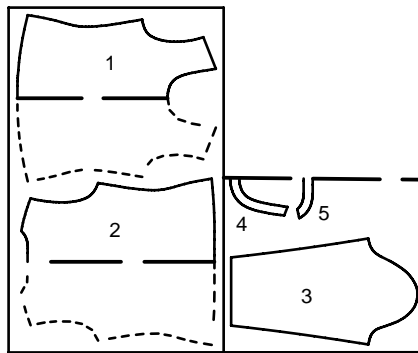

32-44

55" 140 CM

59" 150 CM

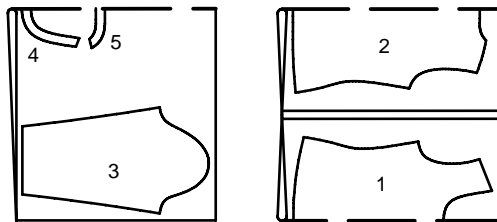

32-44