

burdastyle download 4102

layout drawing

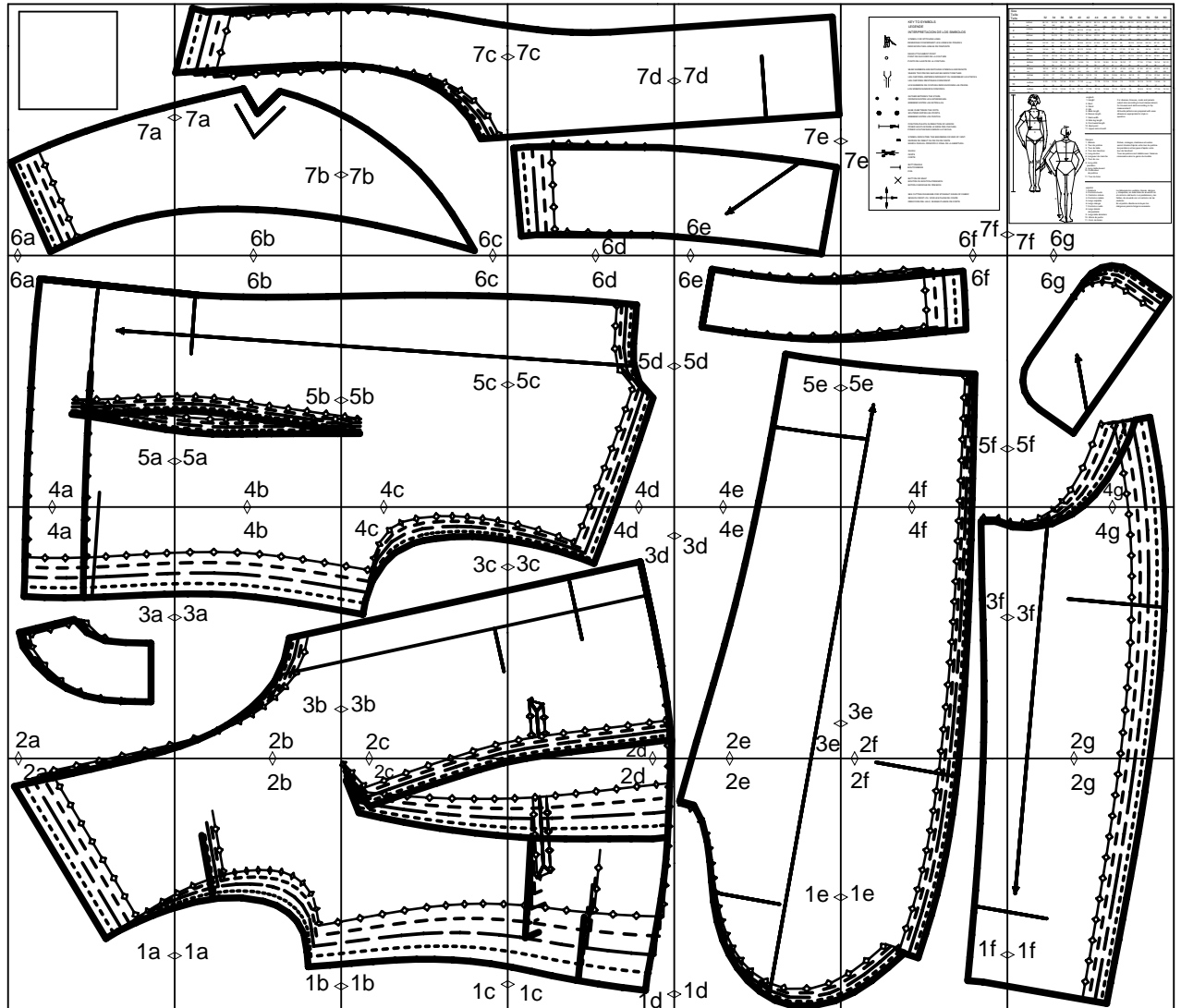

2a

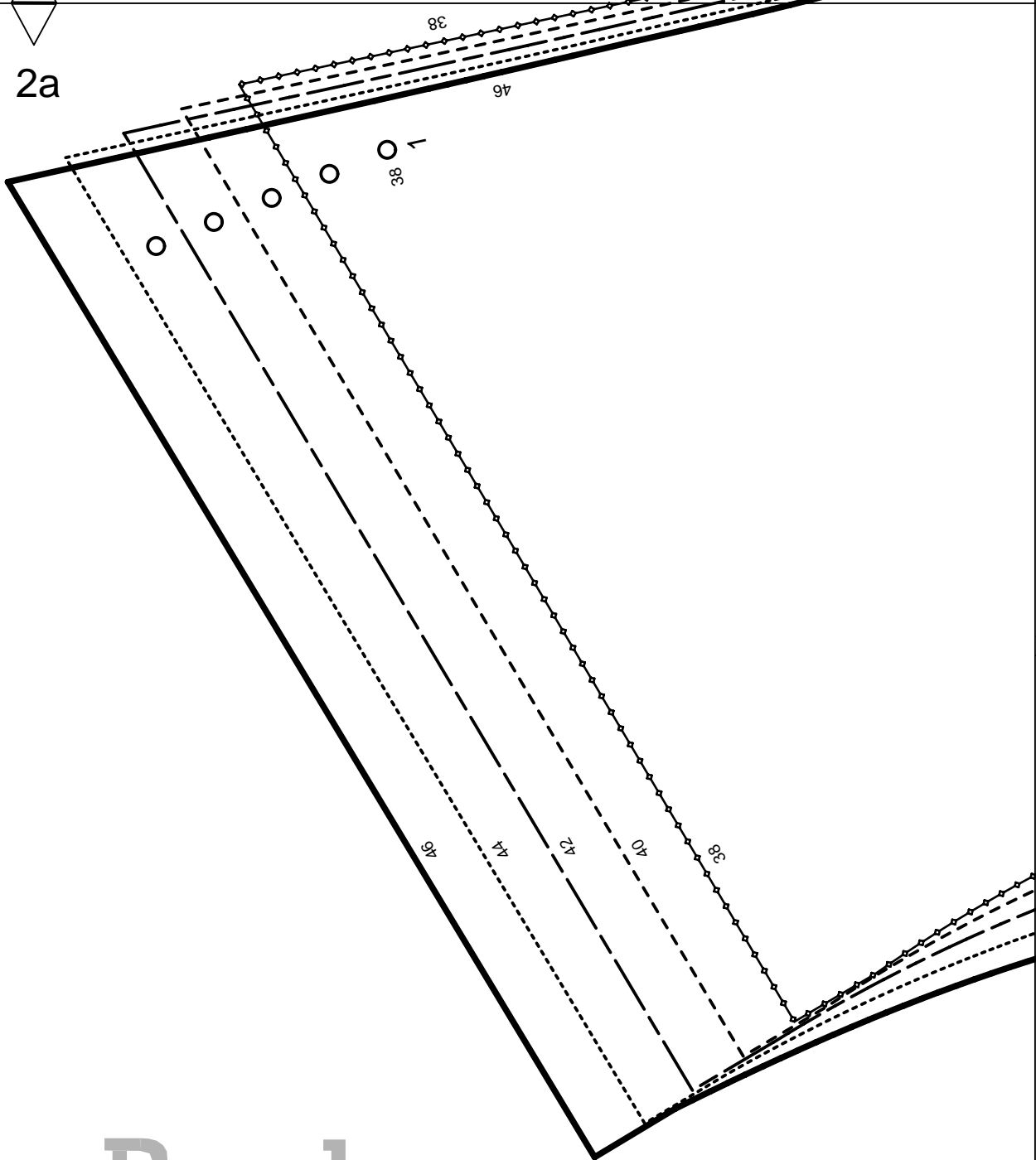

Burda
STYLE

www.burdastyle.com

1a

2b

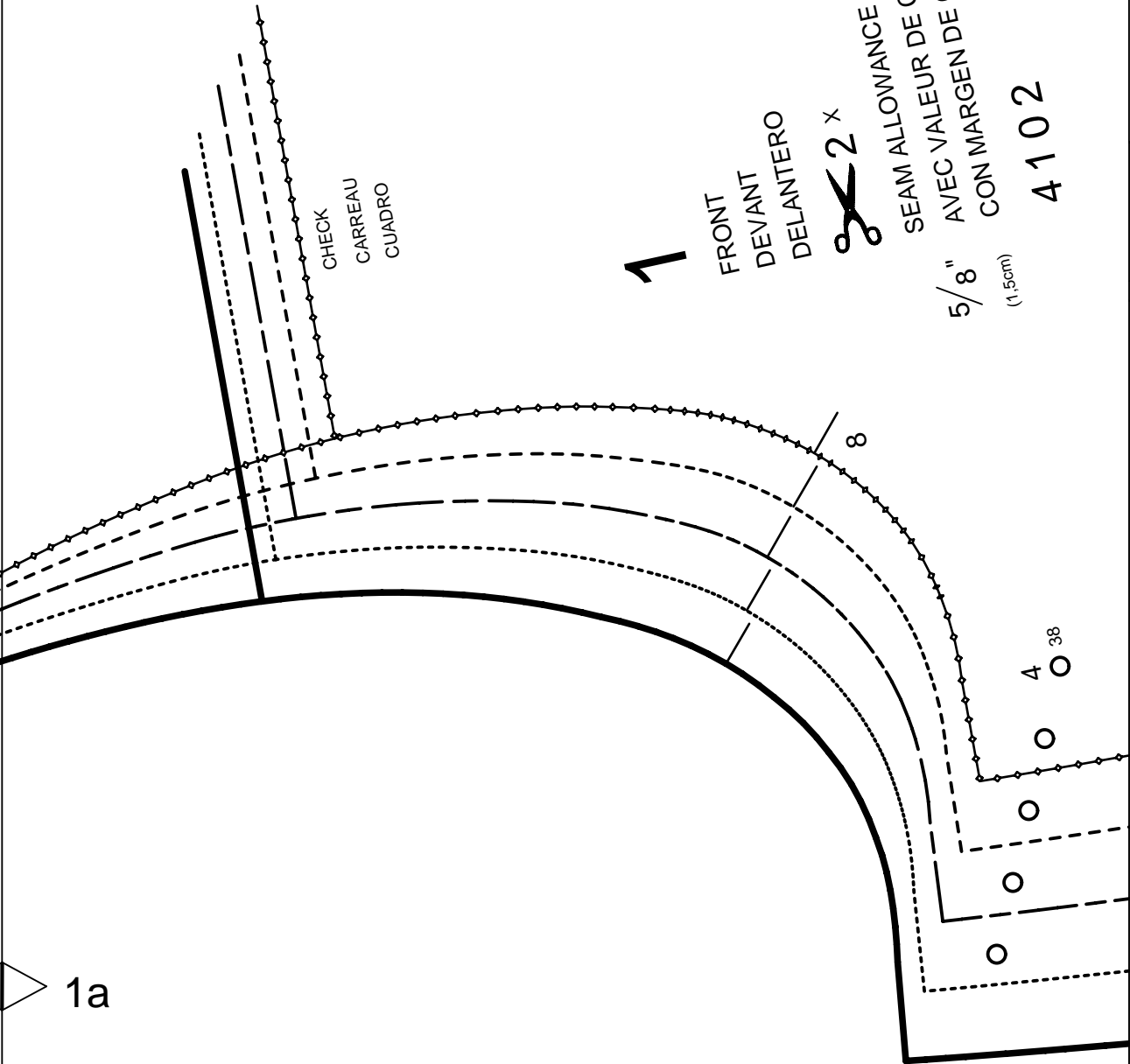

1

FRONT
DEVANT
DELANTERO



SEAM ALLOWANCE INCLUDED
AVEC VALEUR DE COUTURE
CON MARGEN DE COSTURA

5/8" (1.5cm)

4102

1a

1b

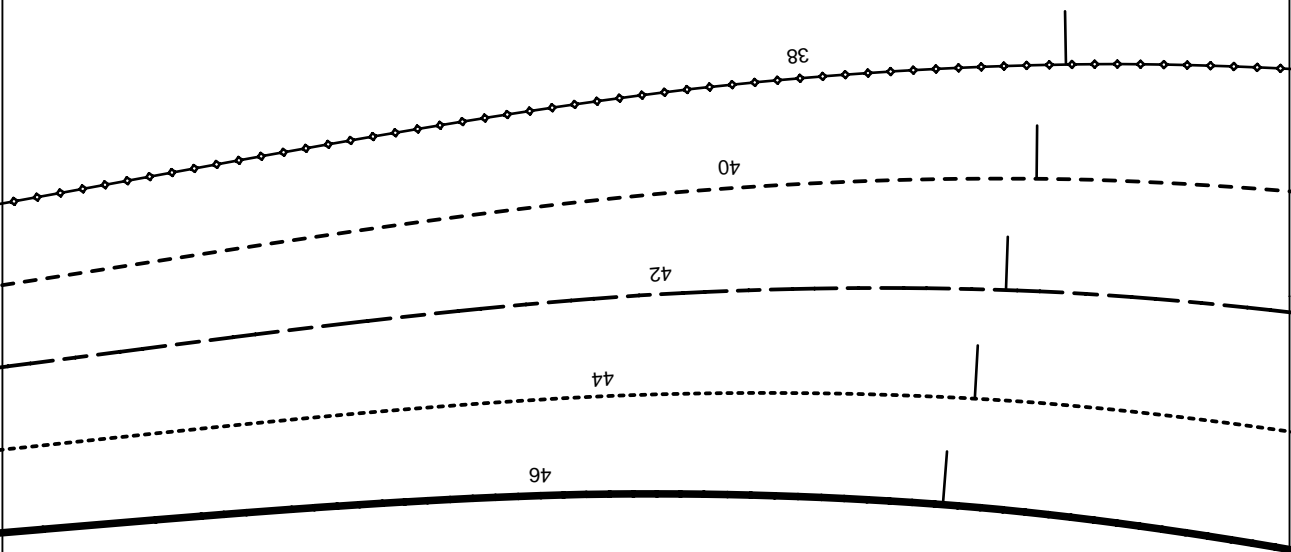
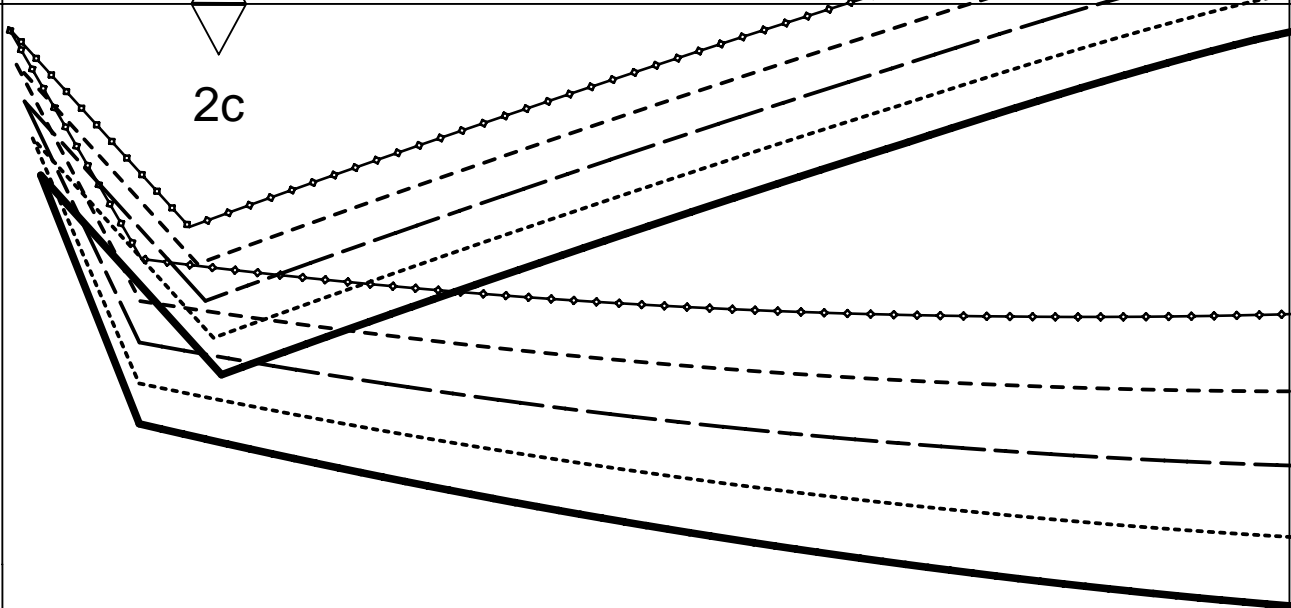

2d

FLAP ATTACHMENT
LIGNE DE MONTAGE DU RABAT
LINEA DE APLICACION CARTERA



PIPING ATTACHMENT
LIGNE DE MONTAGE PASSEPOIL
LINEA DE APLICACION RIBETE

CHECK
CARREAU
CUADRO

46

38

1c

1d

2e

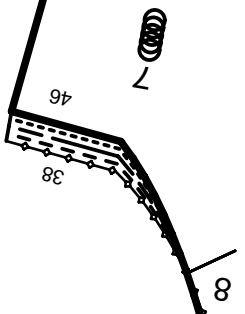

STRAIGHT GRAIN
DROIT FIL
SENTIDO HILO

CHECK
CARREAU
CUADRO

1e

EASE-IN
SOUTENIR
EMBEER

1d

2f

CHECK
CARRAU
CUADRO

38
40
42
44
46

1e

38
5

1f

2g

STRAIGHT GRAIN
DROIT FIL
SENTIDO HILO



BAND PLACEMENT
PAREMENT LIGNE DE RACCORD
CENEFA, LINEA DE TOPE

1f



4a

CHECK
CARRÉAU
CUADRO

3a

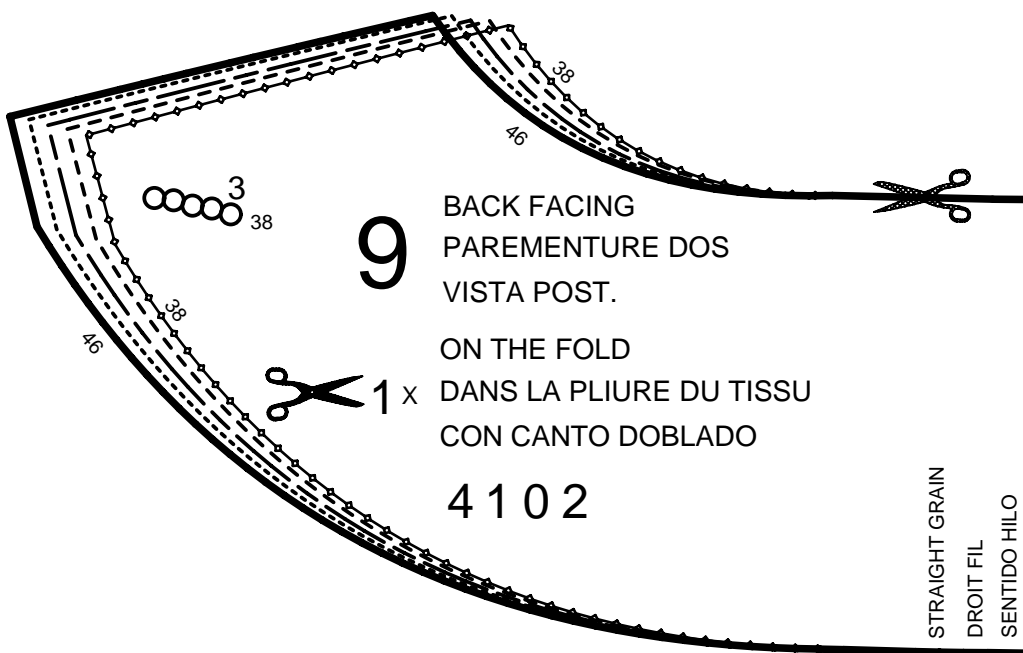

SEAM ALLOWANCE INCLUDED
AVEC VALEUR DE COUTURE
CON MARGEN DE COSTURA

5/8" (1,5cm)

Burda
STYLE

2a

4b

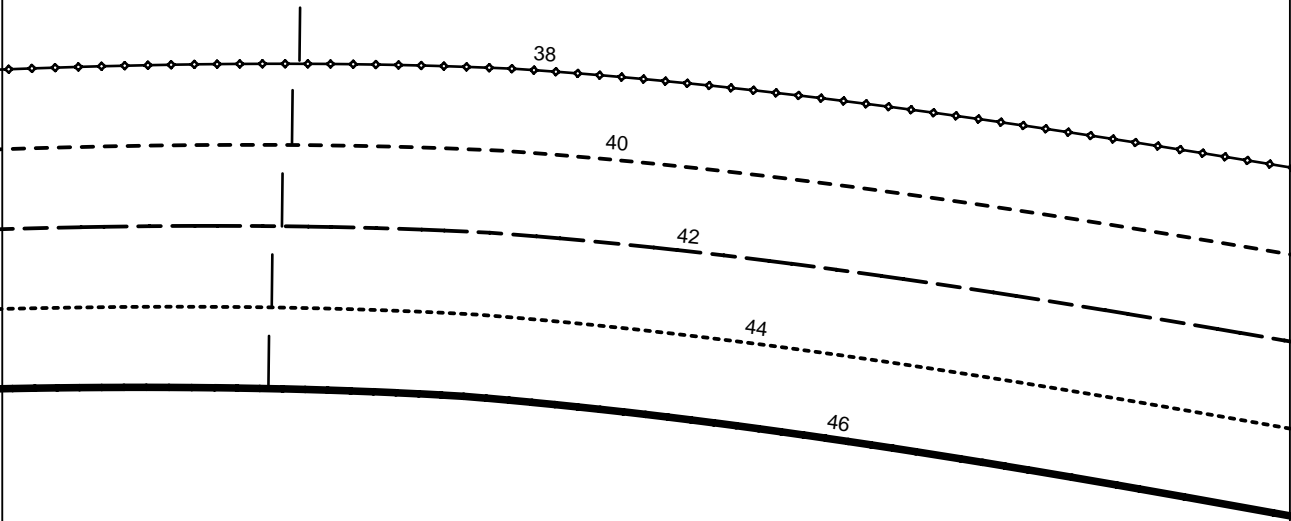

3a

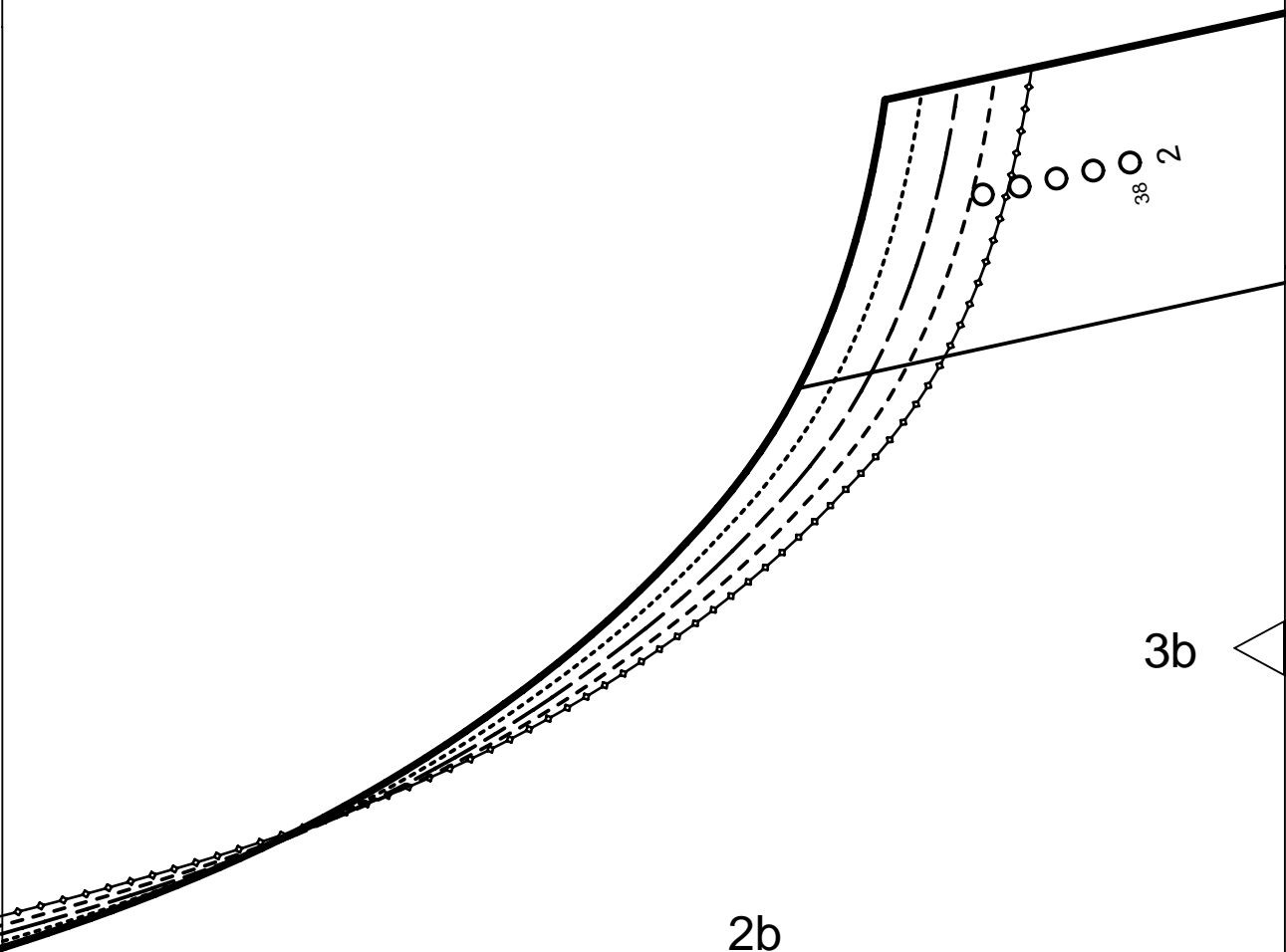

3b

2b

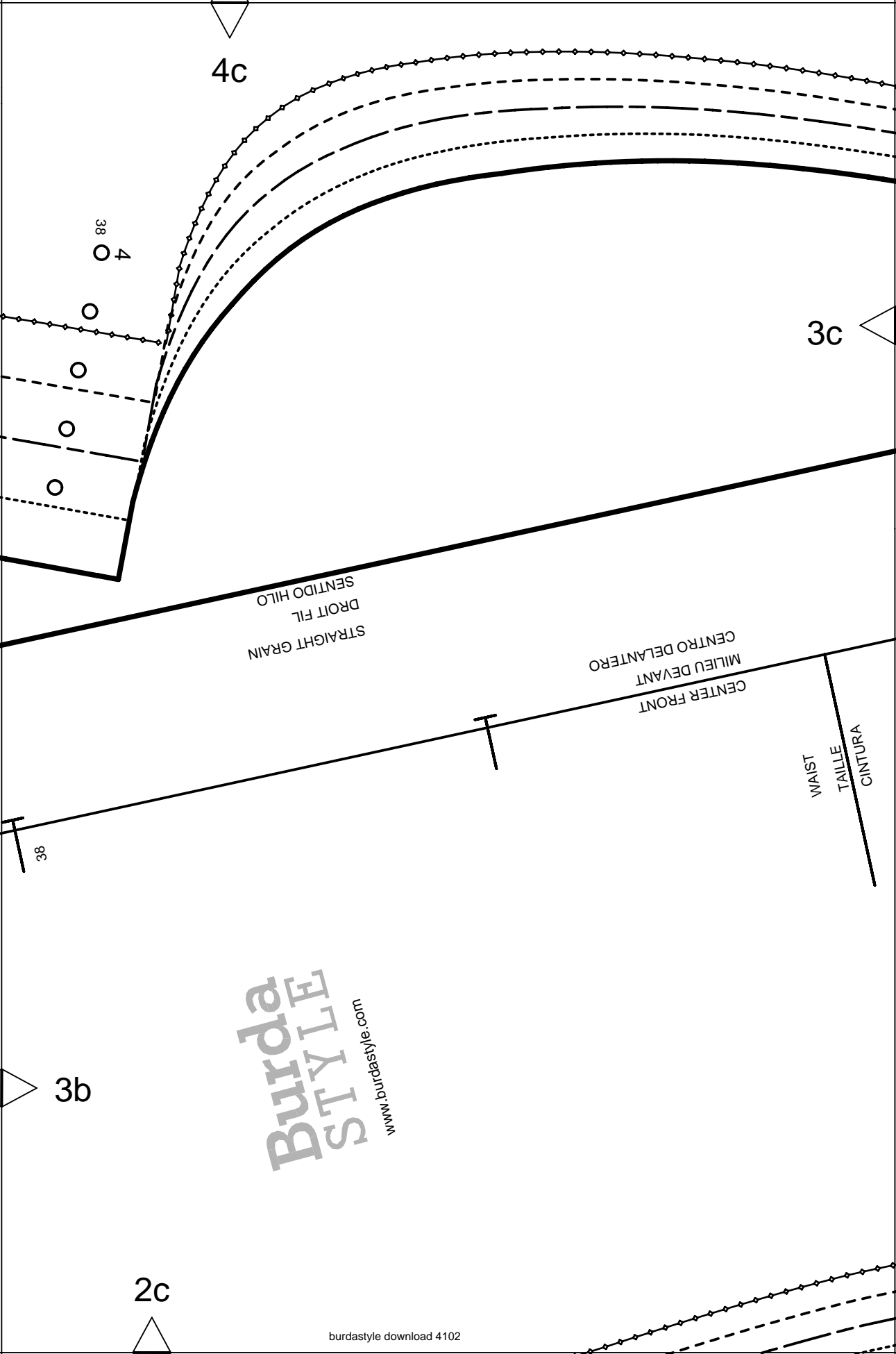

4c

3c

38
4

STRAIGHT GRAIN
DROIT FIL
SENTIDO HILLO

CENTER FRONT
MILIEU DEVANT
CENTRO DELANTERO

WAIST
TAILLE
CINTURA

38

3b

Burda
STYLE
www.burdastyle.com

2c

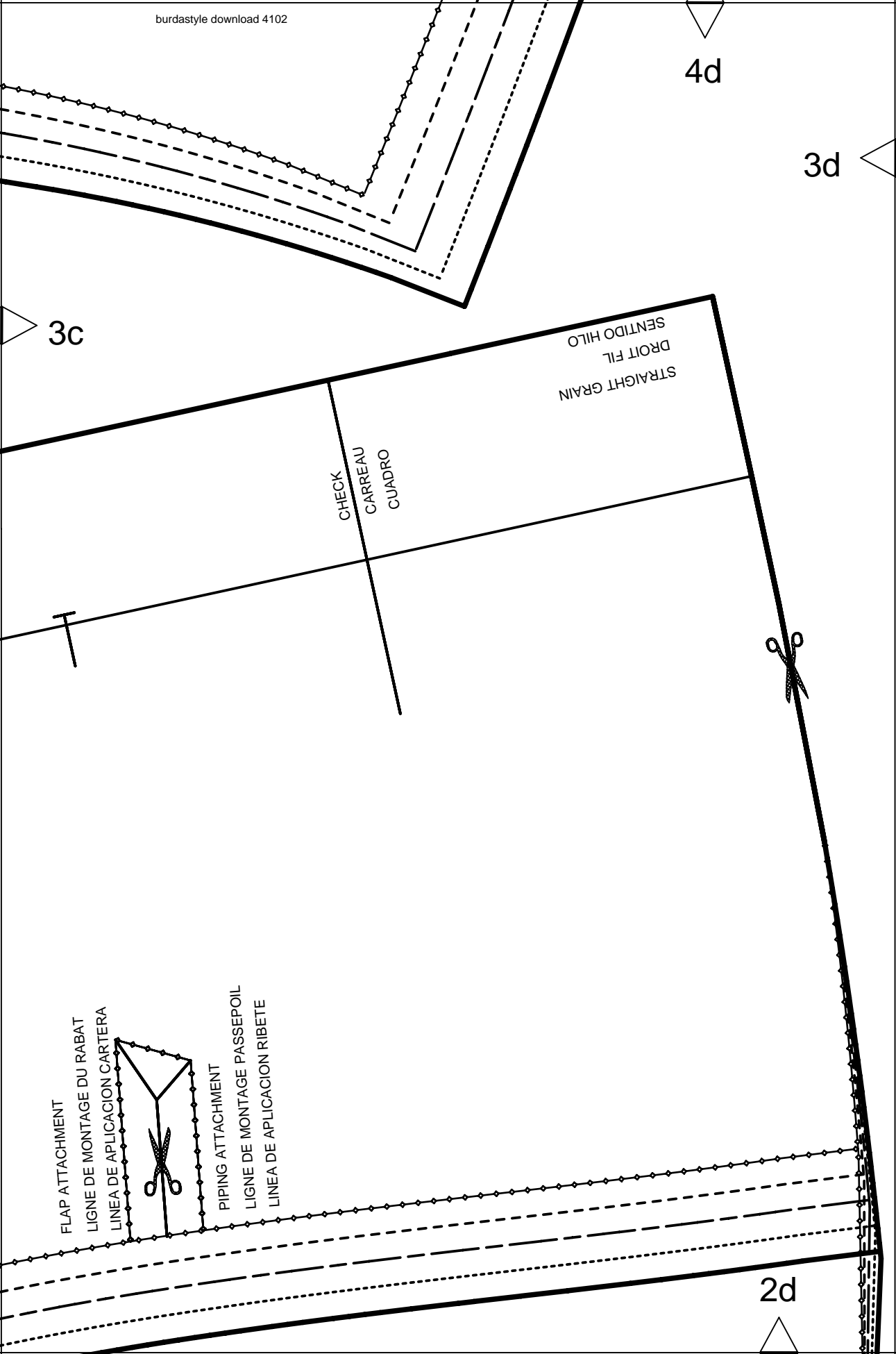

4e

3d

STRAIGHT GRAIN
DROIT FIL
SENTIDO HILO

3e

2e

4f

7

3f

Burda
STYLE
www.burdastyle.com

4102

SEAM ALLOWANCE INCLUDED
AVEC VALEUR DE COUTURE
CON MARGEN DE COSTURA

5/8" (1,5cm)



UPPER SLEEVE
DESSUS DE MANCHE
MANGA SUPERIOR

3

3e

2f

4g

46

44

42

40

38

STRAIGHT GRAIN
DROIT FIL
SENTIDO HILO

CHECK
CARREAU
CUADRO

3f

4

UNDER SLEEVE
DESSOUS DE MANCHE
MANGA INFERIOR



5/8" SEAM ALLOWANCE INCLUDED
(1,5cm) AVEC VALEUR DE COUTURE
CON MARGEN DE COSTURA

4102

Burda
STYLE

www.burdastyle.com

2g

6a



FACING
PAREMENTURE
VISTA

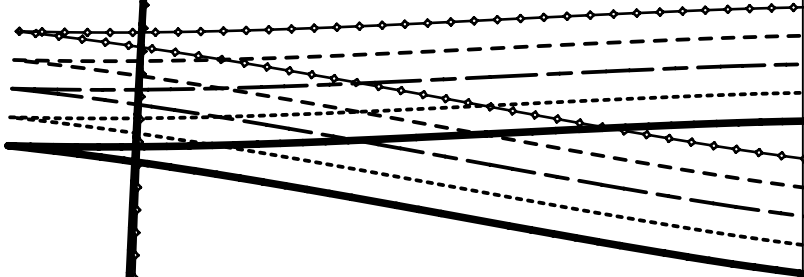

5a

4a

6b

WAIST
TAILLE
CINTURA

STRAIGHT GRAIN
DROIT FIL
SENTIDO HILO

5b

5a

4b

6c

CENTER BACK SEAM
COUTURE MILIEU DOS
CENTRO POST. COSTURA

STRAIGHT GRAIN
DROIT FIL
SENTIDO HILO

5c

2

BACK
DOS
ESPALDA



5/8" (1.5cm)

SEAM ALLOWANCE INCLUDED
AVEC VALEUR DE COUTURE
CON MARGEN DE COSTURA

4102

Burda
STYLE
www.burdastyle.com

5b

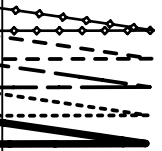

4c

6d

5d

5c

STRAIGHT GRAIN
DROIT FIL
SENTIDO HILO

EASE-IN
SOUTENIR
EMBERBER

4d

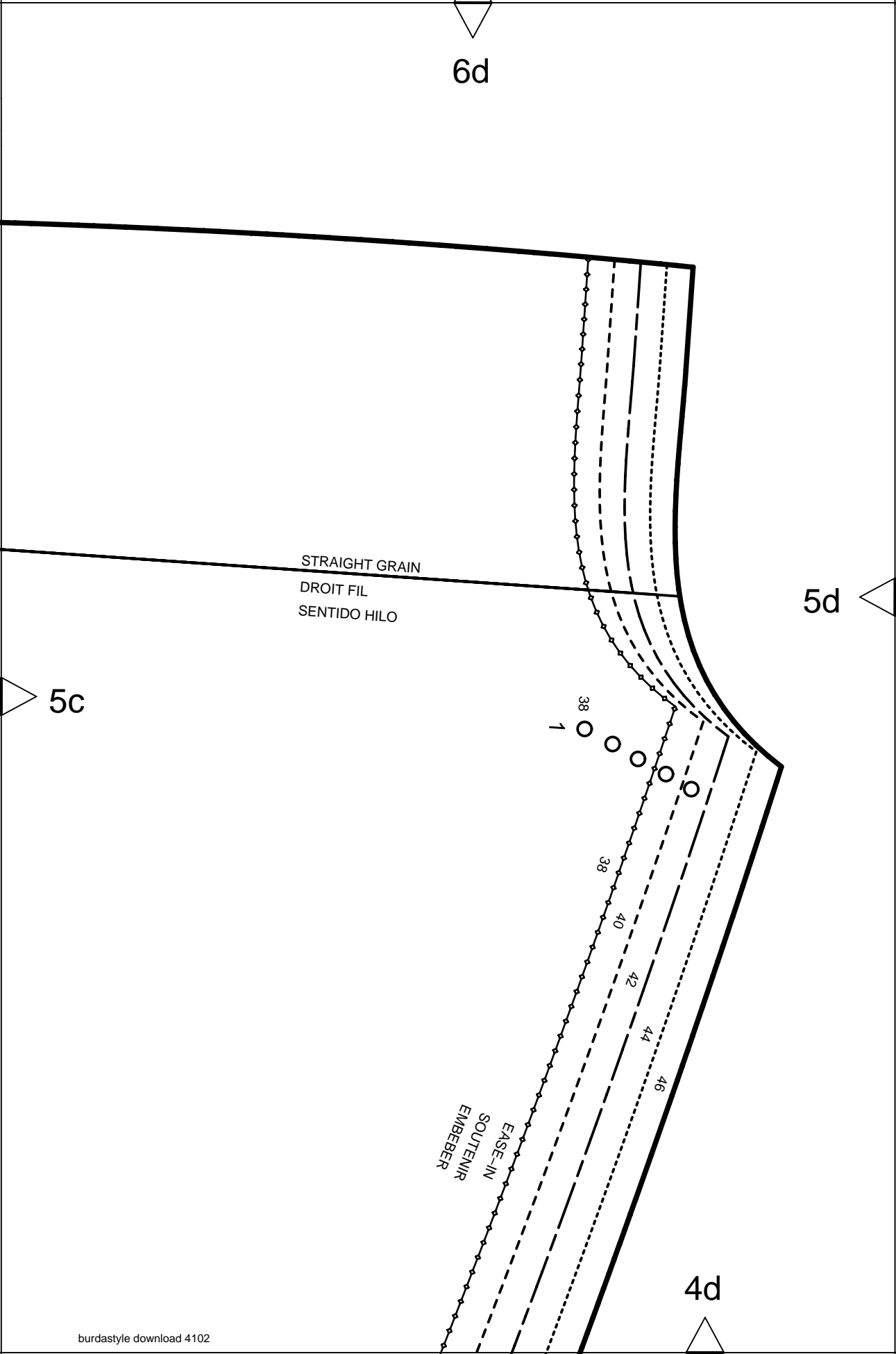

6e

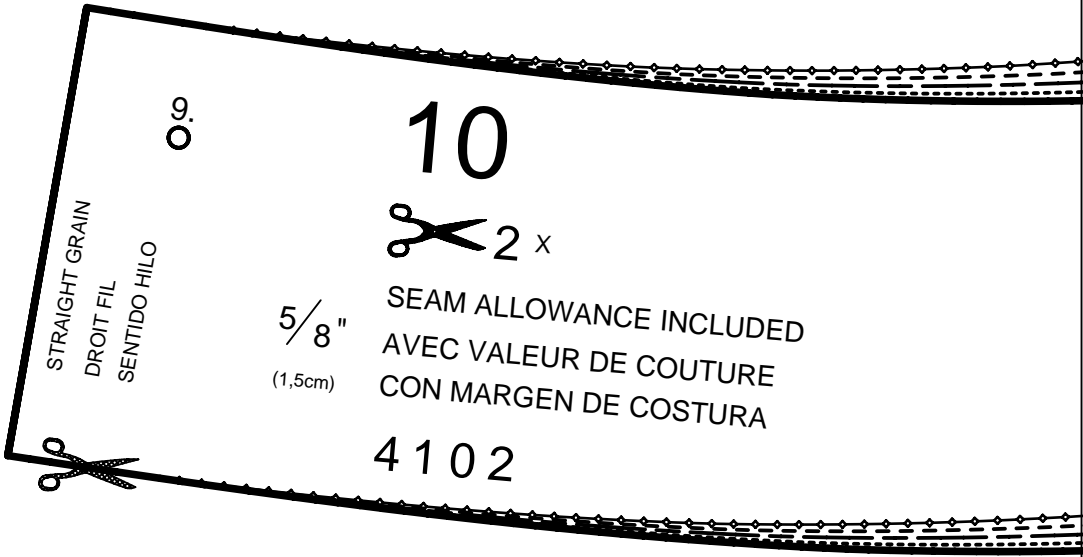

5d

5e

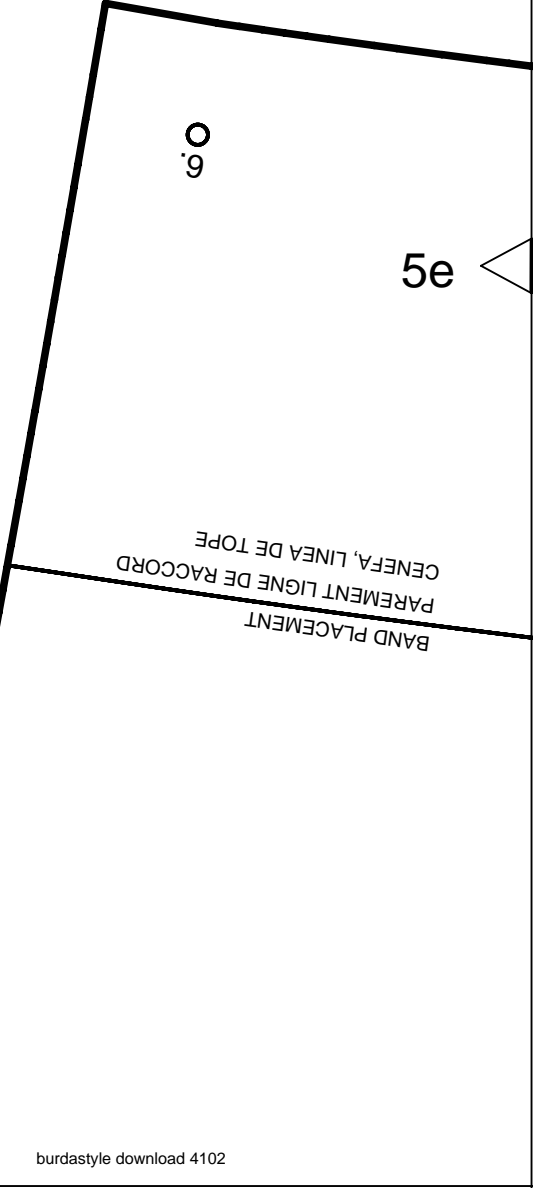

4e

6f

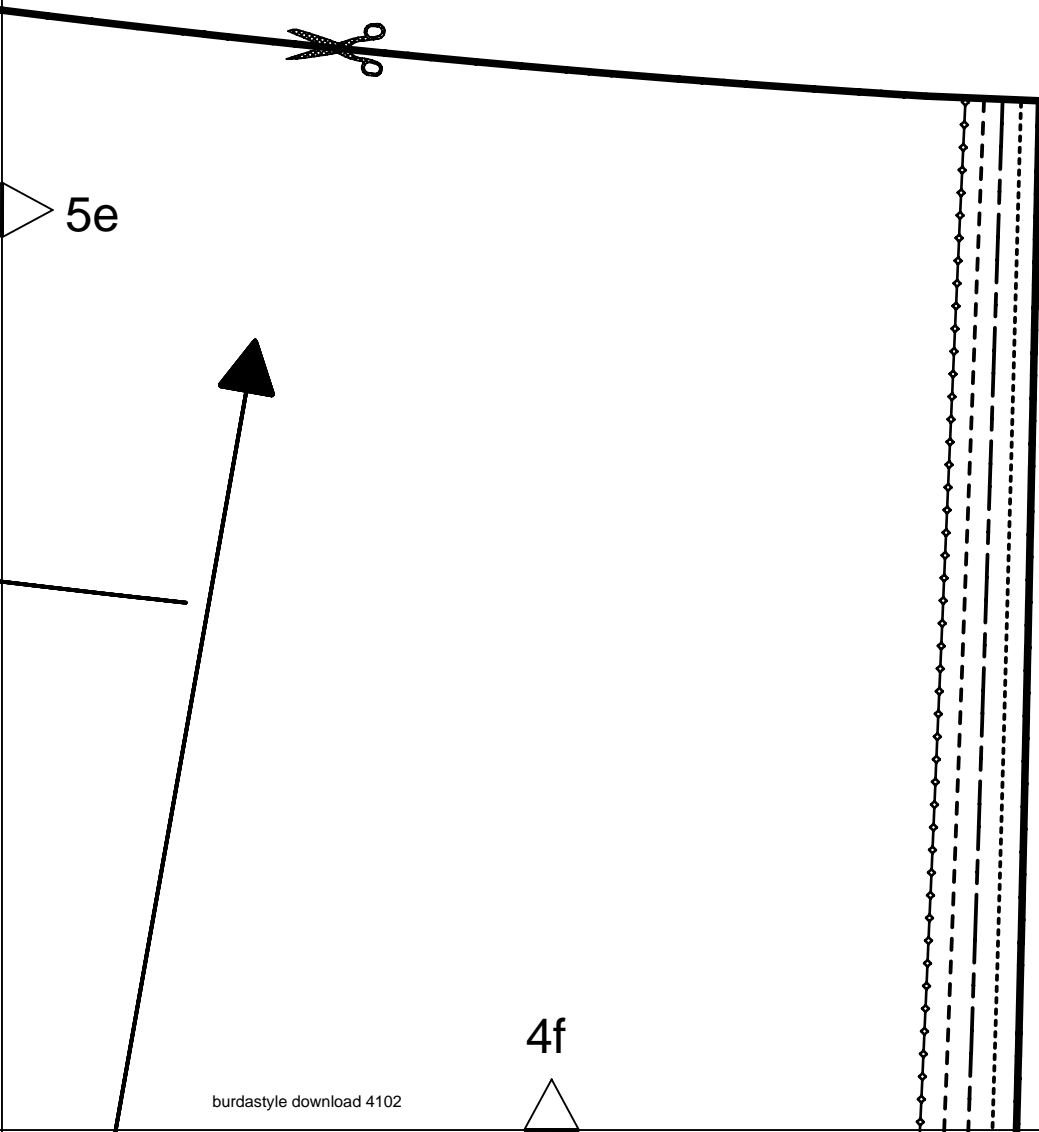
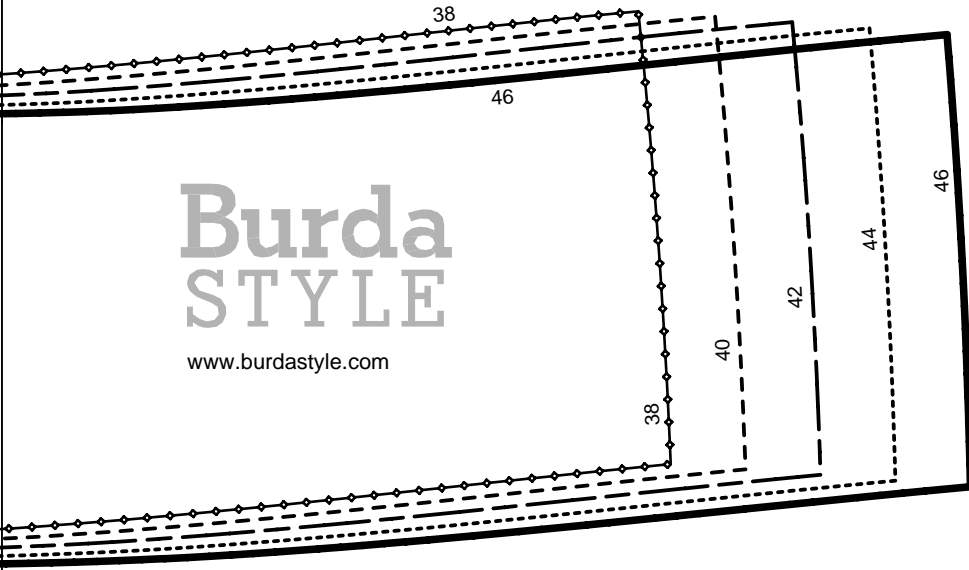

5f

6g

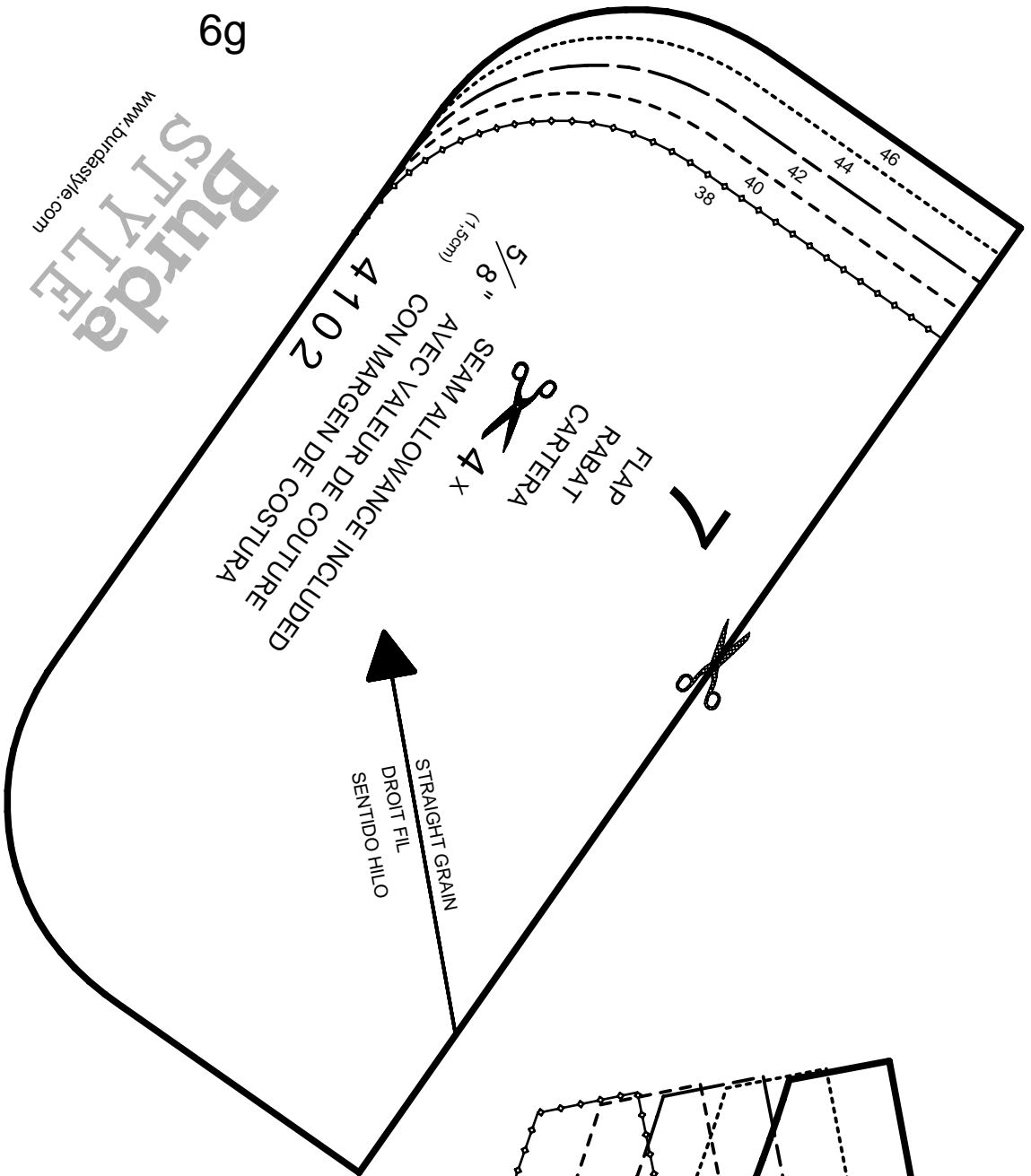

5f

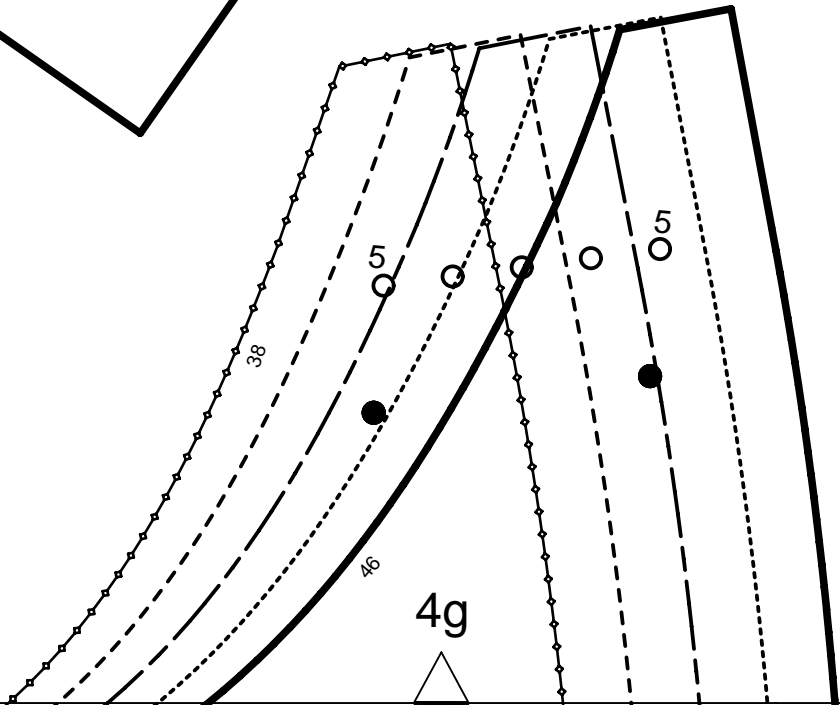

test square

side length

4 inches (10 cm)

7a

6

COLLAR
COL
CUELLO

ON THE FOLD
DANS LA PLIURE DU TISSU
CON CANTO DOBLADO

SEAM ALLOWANCE INCLUDED
AVEC VALEUR DE COUTURE
CON MARGEN DE COSTURA



5/8"
(1.5cm)

4102

CENTER BACK FOLD STRAIGHT GRAIN
PLIURE DU TISSU MILIEU DOS DROIT FIL
CENTRO POSTERIOR DOBLEZ DIR:HILO

46
44
42
40
38

46
38

6a

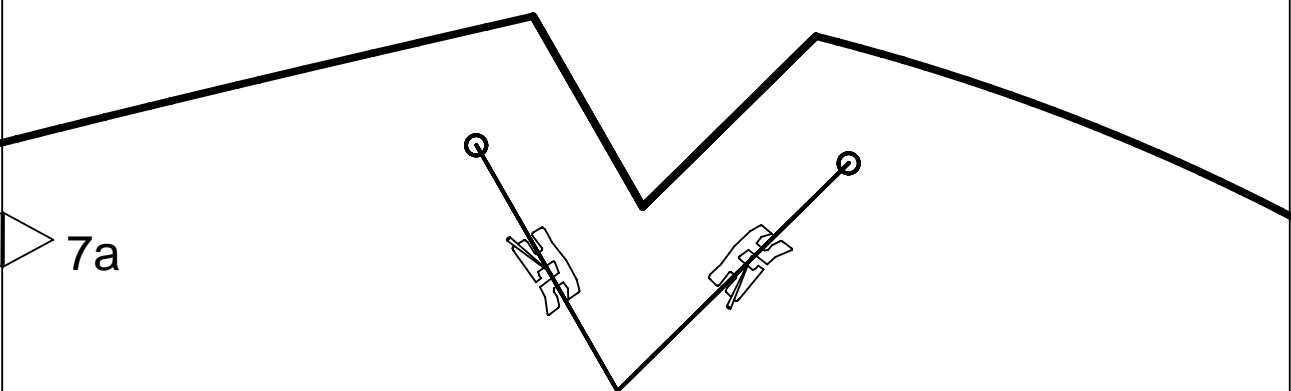
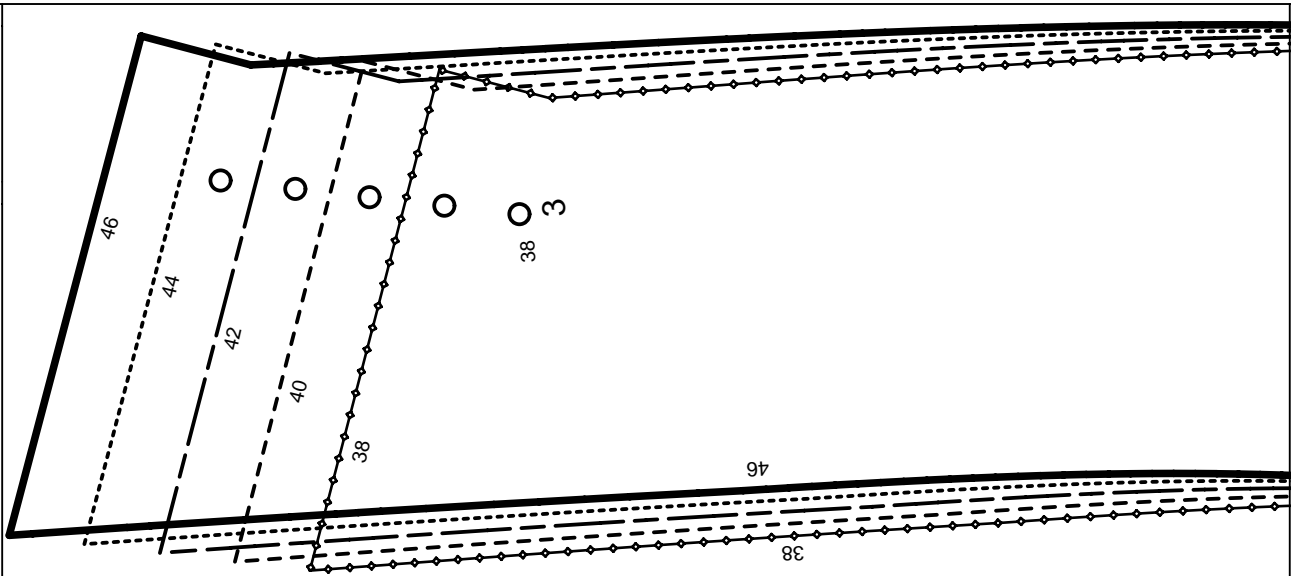

7a

Burda
STYLE
www.burdastyle.com

7b



6b

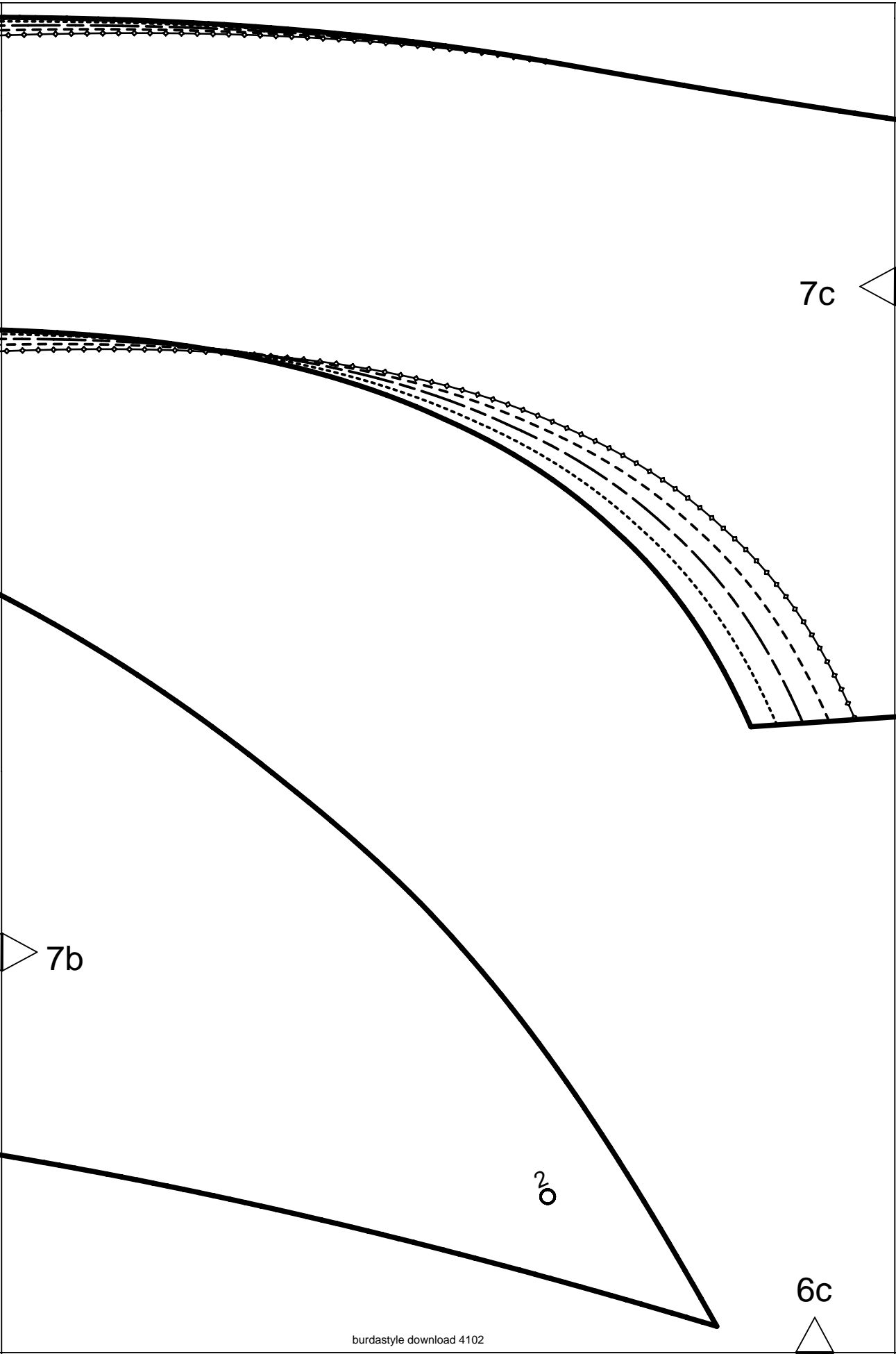

7c

7b

v
o

6c

7c

8

FRONT FACING
PAREMENTURE DEVANT
VISTA DELANTERA



SEAM ALLOWANCE INCLUDED
AVEC VALEUR DE COUTURE
CON MARGEN DE COSTURA

4102

Burda
STYLE

www.burdastyle.com

7d

STRAIGHT GRAIN
DROIT FIL
SENTIDO HILO

5/8"
(1,5cm)

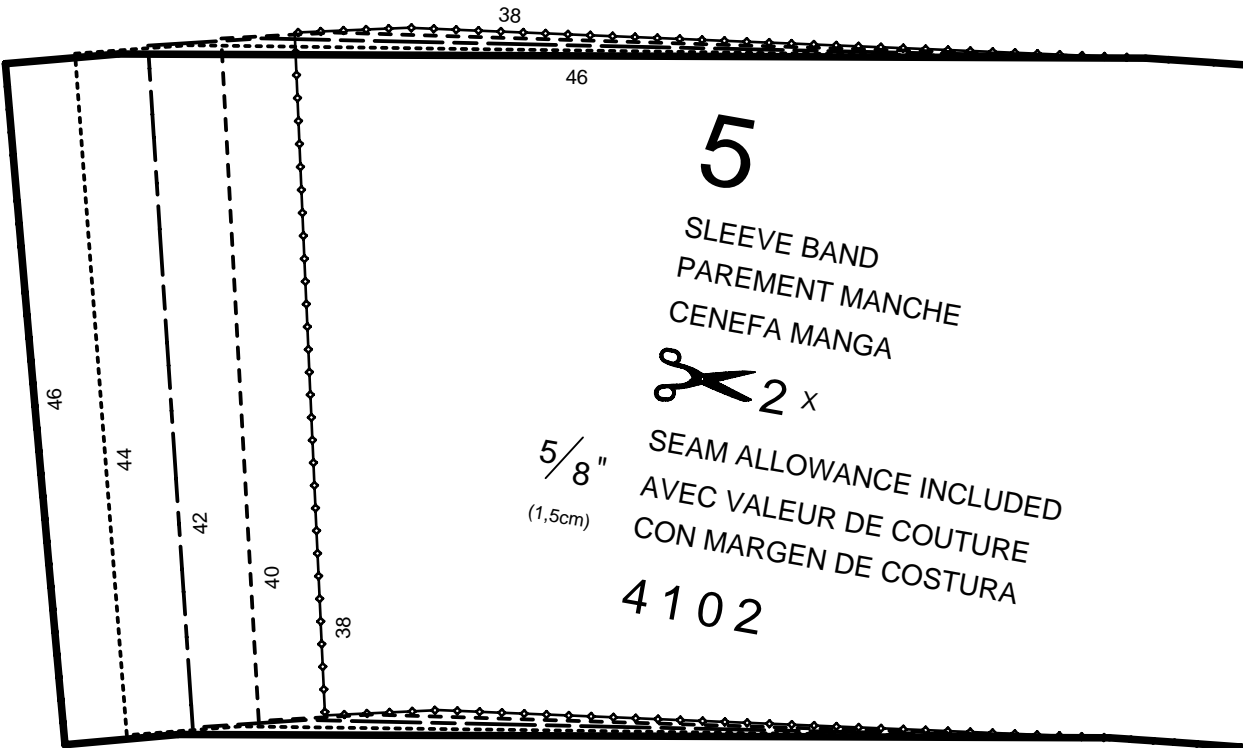

5

SLEEVE BAND
PAREMENT MANCHE
CENEFA MANGA



5/8"
(1,5cm)

SEAM ALLOWANCE INCLUDED
AVEC VALEUR DE COUTURE
CON MARGEN DE COSTURA

4102

6d

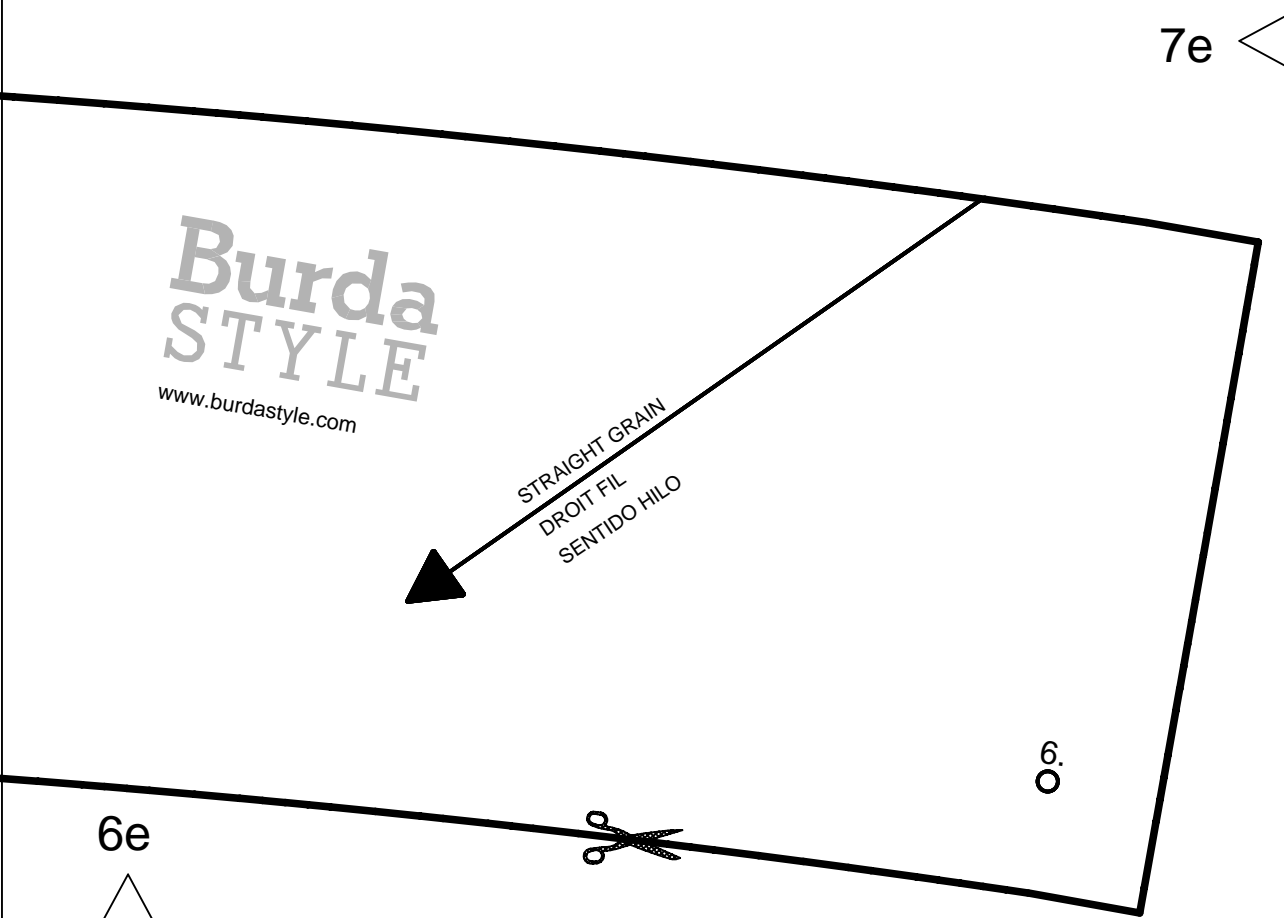
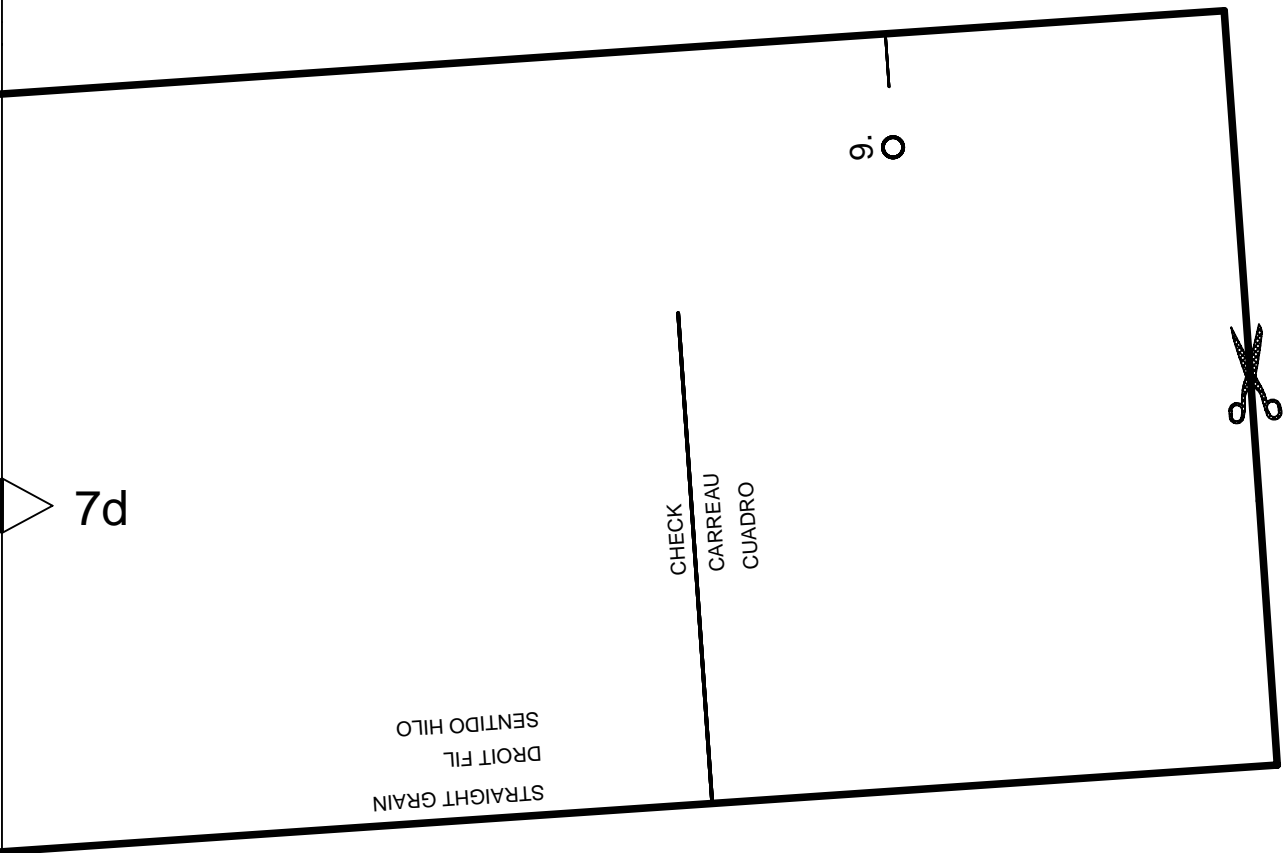

7e

KEY TO SYMBOLS

LEGENDE

INTERPRETACION DE LOS SIMBOLOS



SYMBOL FOR STITCHING LINES
REMARQUE CONCERNANT LES LIGNES DE PIGNES
INDICACION PARA LINEAS DE PESPUNTE



SEAM ATTACHMENT POINT
POINT DE RACCORD DE LA COUTURE
PUNTO DE AJUSTE DE LA COSTURA



SEAM NUMBERS ARE MATCHING SYMBOLS AND DENOTE
WHERE TWO PIECES SHOULD BE SEWN TOGETHER.
LES CHIFFRES-REPERES INDIQUENT OU ASSEMBLER LES PIECES.
LES CHIFFRES IDENTIQUES COINCIDENT.
LOS NUMEROS DE COSTURA INDICAN DONDE LAS PIEZAS.
LOS MISMOS NUMEROS COINCIDEN.



GATHER BETWEEN THE STARS.
FRONCER ENTRE LES ASTERISQUES.
EMBEBER ENTRE LAS ESTRELLAS.



EASE IN BETWEEN THE DOTS.
SOUTENIR ENTRE LES POINTS.
EMBEBER ENTRE LOS PUNTOS.

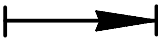

POSITION PLEATS IN DIRECTION OF ARROW.
POSER LES PLIS DANS LE SENS DES FLECHES.
PONER LOS PLIEQUES SEGUN LA FLECHA.



SYMBOL INDICATING THE BEGINNING OR END OF VENT.
REPERE DE DEBUT OU DE FIN DE FENTE.
MARCA PARA EL PRINCIPIO O FINAL DE LA ABERTURA.



SLASH
FENTE
CORTE



BUTTONHOLE
BOUTONNIERE
OIAL



BUTTON OR SNAP
BOUTON OU BOUTON-PRESSION
BOTON O BROCHE DE PRESION

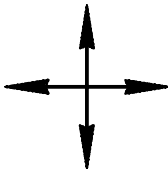

SEE CUTTING DIAGRAMS FOR STRAIGHT GRAIN OF FABRIC
SENS DU DROIT-FIL VOIR LES PLANS DE COUPE
DIRECCION DEL HILO, VEANSE PLANOS DE CORTE

7e

7f

6f

Size Taille Talla		32	34	36	38	40	42	44	46	48	50	52	54	56	58	60
1	inches	66 1/4	66 1/4	66 1/4	66 1/4	66 1/4	66 1/4	66 1/4	66 1/4	66 1/4	66 1/4	66 1/4	66 1/4	66 1/4	66 1/4	66 1/4
	cm	168	168	168	168	168	168	168	168	168	168	168	168	168	168	168
2	inches	30	31 1/2	33	34 3/4	36 1/4	37 3/4	39 1/2	41	43 1/2	45 1/2	48	50 1/2	52 3/4	55 1/4	57 1/2
	cm	76	80	84	88	92	96	100	104	110	116	122	128	134	140	146
3	inches	23	24 1/2	26	27 3/4	29 1/4	30 3/4	32 1/2	34	36 1/4	38 3/4	41	43 1/2	45 1/2	48	50 1/2
	cm	58	62	66	70	74	78	82	86	92	98	104	110	116	122	128
4	inches	32 1/2	34	35 1/2	37	38 3/4	40 1/4	41 3/4	43 1/2	45 1/2	48	50 1/2	52 3/4	55 1/4	57 1/2	60
	cm	82	86	90	94	98	102	106	110	116	122	128	134	140	146	152
5	inches	15 3/4	16	16 1/4	16 1/2	16 1/2	16 3/4	17	17 1/4	17 1/4	17 1/2	17 3/4	18	18 1/4	18 1/2	18 1/2
	cm	40	40.5	41	41.5	42	42.5	43	43.5	44	44.5	45	45.5	46	46.5	47
6	inches	23 1/4	23 1/4	23 1/4	23 3/4	23 3/4	24	24	24	24	24 1/2	24 1/2	24 1/2	24 3/4	24 3/4	24 3/4
	cm	59	59	59	60	60	61	61	61	61	62	62	62	63	63	63
7	inches	13	13 1/2	14 1/4	14 1/2	14 3/4	15	15 1/2	15 3/4	16 1/4	16 1/2	17	17 1/4	17 3/4	18 1/4	18 1/2
	cm	33	34	35	36	37	38	39	40	41	42	43	44	45	46	47
8	inches	39 3/4	40 1/4	40 1/4	40 3/4	41	41	41 1/2	41 1/2	41 1/2	41 3/4	41 3/4	41 3/4	42 1/4	42 1/2	42 1/2
	cm	101	102	102	103	104	104	105	105	105	106	106	106	107	108	108
9	inches	16 1/2	17	17 1/4	17 3/4	18 1/4	18 1/2	19	19 1/4	19 3/4	20 1/4	20 1/2	21	21 1/4	21 3/4	22 1/4
	cm	42	43	44	45	46	47	48	49	50	51	52	53	54	55	56
10	inches	9 1/2	9 7/8	10 1/4	10 3/4	11 1/8	11 1/2	11 7/8	12 1/4	12 3/4	13	13 1/2	14 1/4	14 1/2	14 3/4	15
	cm	24	25	26	27	28	29	30	31	32	33	34	35	36	37	38
11	inches	9 7/8	10 1/4	10 3/4	11 1/8	11 1/2	11 7/8	12 1/4	12 3/4	13 1/2	14 1/2	15	15 3/4	16 1/2	17 1/4	18 1/4
	cm	25	26	27	28	29	30	31	32	34	36	38	40	42	44	46

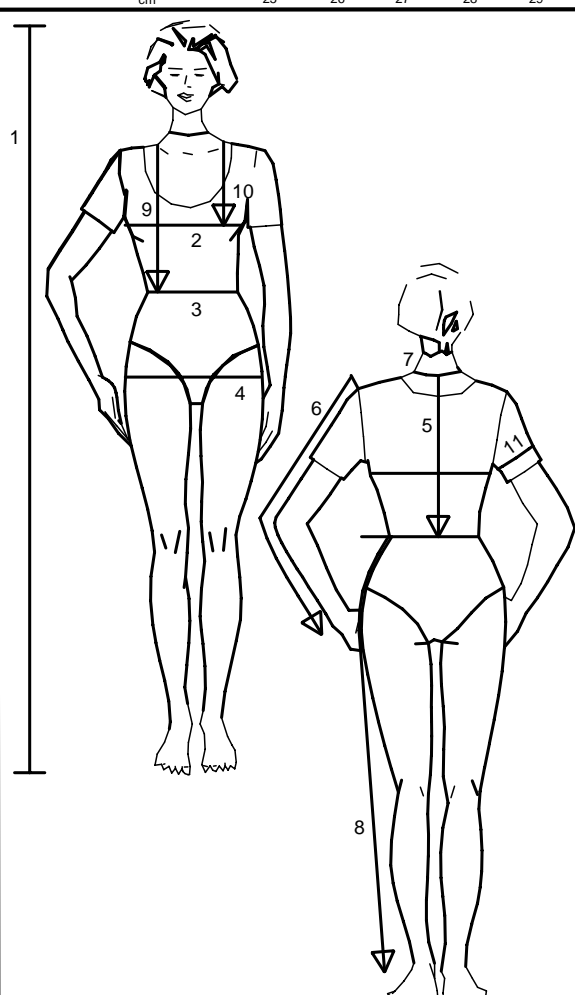

englisch

1. Height
2. Bust
3. Waist
4. Hip
5. Back length
6. Sleeve length
7. Neck width
8. Side leg length
9. Front waist length
10. Bust point
11. Upper arm circumf.

For dresses, blouses, coats and jackets select size according to bust measurement, for trousers and skirts according to hip measurement!
All burda patterns are prepared with ease allowance appropriate for style in question.

français

1. Stature
2. Tour de poitrine
3. Tour de taille
4. Tour des hanches
5. Long. du dos
6. Longueur de manche
7. Tour de cou
8. Long. côté pantalon
9. Long. taille devant
10. Profondeur de poitrine
11. Tour du bras

Robes, corsages, manteaux et vestes seront choisis d'après votre tour de poitrine les pantalons et les jupes d'après votre tour de hanches!
Tous les patrons sont établis avec l'aisance nécessaire selon le genre du modèle.

español

1. Estatura
2. Contorno busto
3. Contorno cintura
4. Contorno cadera
5. Largo espalda
6. Largo manga
7. Contorno cuello
8. Largo lateral del pantalón
9. Largo talle delantero
10. Altura de pecho
11. Cont. de brazo

La talla para los vestidos, blusas, abrigos y chaquetas, se determina de acuerdo con el contorno del busto. Los pantalones y las faldas, de acuerdo con el contorno de las caderas.
En el patrón-Burda se incluyen los márgenes para la holgura necesaria.